

# NM4, NMS4 60 Hz



Close Coupled Centrifugal Pumps  $n \approx 1750$  rpm  
 Bombas centrífugas monobloc  $n \approx 1750$  1/min



Coverage chart - Campo de aplicaciones

$n \approx 1750$  rpm

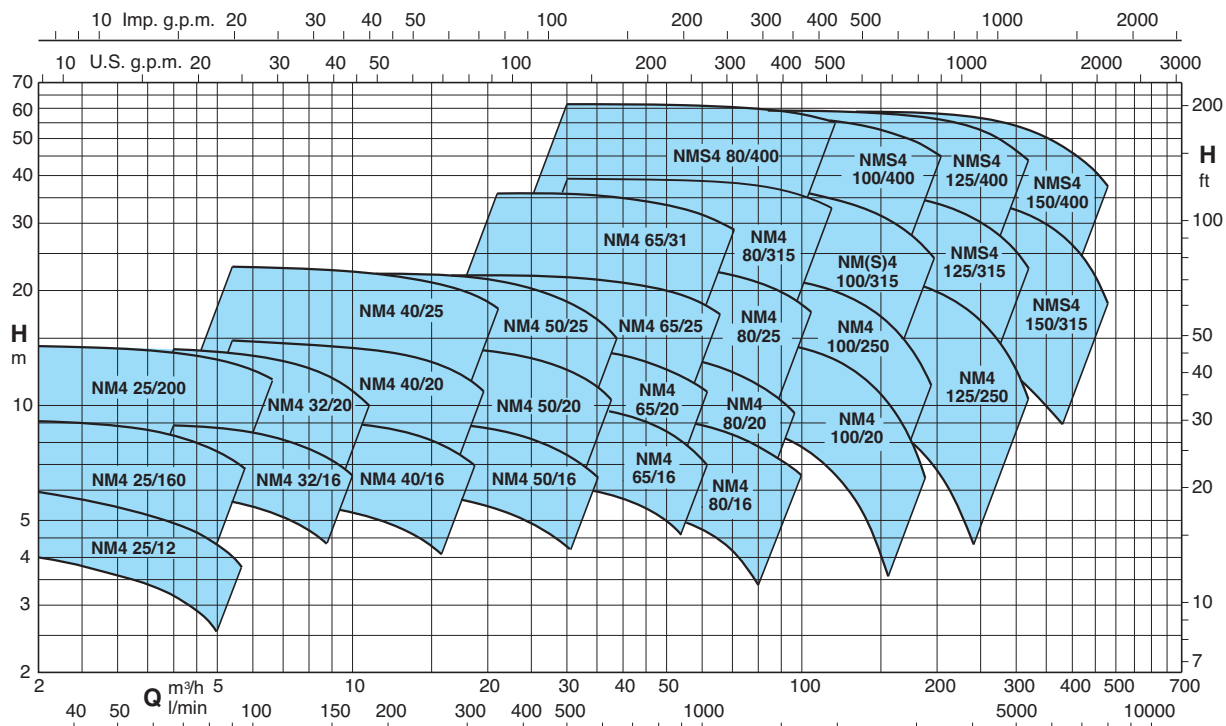

## Construction

Close-coupled centrifugal pumps; electric motor with extended shaft directly connected to the pump up to 15 kW, new bracket construction for standard motors (Stub-shaft construction) from 18,5 to 75 kW with integrated thrust bearing. Pump casing with axial suction and radial delivery on top, main dimensions and performance according to EN 733 with additional sizes for completion.

NM(S)4: version with pump casing and lantern bracket in cast iron.

B-NM(S)4: version with pump casing and lantern bracket/casing cover in bronze. (the pumps are supplied fully painted).

### Connections

Sizes	Connections
NM4 25/125, 25/160, 25/200	Threaded ports ISO 228 Threaded ports <b>NPT</b> (ANSI/ASME B1.20.1) on request
from NM4 32/.. to NMS4 150/..	Flanges according to PN 10, EN 1092-2

### Counter-flanges (on request)

Sizes	Flanges
from NM4 32/.. to NM4 50/..	Screwed flanges EN 1092-1, PN 16
from NM4 32/.. to NMS4 150/400	Flanges for welding EN 1092-1, PN 10

### Version with frequency converter (on request)

## Applications

- For clean liquids without abrasives, which are non-aggressive for the pump materials (contents of solids up to 0,2%).
- For water supply.
- For heating, air conditioning, cooling and circulation plants.
- For civil and industrial applications.
- When low noise operating is required.
- For irrigation.

## Operating conditions

Liquid temperature from -10 °C to +90 °C.

Ambient temperature up to 40 °C.

Total suction lift up to 7 m.

Maximum permissible working pressure up to 10 bar (16 bar for NM4 40/16,20; NM4 50/16; N4M 65/16,20,25; NM4 80/16).

Continuous duty.

## Motor

4-pole induction motor, 60 Hz (n ≈ 1750 rpm).

**NM4, NMS4:** three-phase 220/380 V, 220/440 V, up to 3 kW;  
380/660 V, from 4 to 75 kW;

Insulation class F.

Protection IP 54 (IP 55 for NMS4).

Motor suitable for operation with frequency converter from 1,1 kW.

**Classification scheme IE3 for three-phase motors from 0,75 kW.**

Constructed in accordance with: EN 60034-1; EN 60034-30-1.

## Special features on request

- Other voltages.
- Protection IP 55.
- Special mechanical seal.
- Higher or lower liquid or ambient temperatures.
- Motor suitable for operation with frequency converter up to 0,75 kW.

## Material

Components	NM4, NMS4	B-NM4, B-NMS4
Pump casing Lantern bracket NM4 Casing cover for NMS4	Cast iron GJL 200 EN 1561	Bronze G-Cu Sn 10 EN 1982
Lantern bracket NMS4	Cast iron GJL 200 EN 1561	
Impeller	Cast iron GJL 200 EN 1561	Bronze G-Cu Sn 10 EN 1982
	Brass P- Cu Zn 40 Pb 2 UNI 5705 For NM4 25/12 - 25/160 - 25/200 - 32/16 - 32/20 - 40/20	
Shaft	AISI 303 up to 1,1 kW	Cr Ni Mo steel
	AISI 430 from 1,5 kW to 75 kW	AISI 316
Mechanical seal	Carbon - Ceramic - NBR	
Counter-flanges	Steel Fe 430B UNI 7070	

## Ejecución

Electrobombas centrífugas monobloc con acoplamiento directo motor-bomba y eje único hasta 15 kW, ejecución para motores normalizados IEC con cojinete axial integrado desde 18,5 hasta 75 kW (ejecución Stub-shaft). Cuerpo bomba con orificio de aspiración axial y orificio de impulsión vertical-radial, con dimensiones principales y prestaciones según EN 733, con otros modelos adjuntos complementarias.

NM(S)4: Ejecución con cuerpo bomba y acoplamiento en hierro.

B-NM(S)4: Ejecución con cuerpo bomba y acoplamiento/tapa del cuerpo en bronce. (Las bombas en bronce se suministran totalmente pintadas).

### Orificios

Modelos	Orificios
NM4 25/125, 25/160, 25/200	Roscados ISO 228 Roscados <b>NPT</b> (ANSI/ASME B1.20.1) bajo demanda
de NM4 32/.. a NM4 150/..	Bridas PN 10, EN 1092-2

### Contrabridas bajo demanda

Modelos	Bridas
de NM4 32/.. a NM4 50/..	Bridas roscadas EN 1092-1, PN 16
de NM4 65/.. a NMS4 150/..	Bridas para soldar con aportación EN 1092-1, PN 10

### Versión con variador de frecuencia (bajo demanda)

## Aplicaciones

- Para líquidos limpios sin partes abrasivas, y no agresivas para los materiales de la bomba (con partes sólidas hasta 0,2% máx).
- Para el aprovisionamiento de agua.
- Para instalaciones de calefacción, acondicionamiento, refrigeración y circulación. - Para aplicaciones civiles e industriales.
- Cuando es requerido un funcionamiento de bajo nivel sonoro.
- Para irrigación.

## Límites de empleo

Temperatura del líquido de -10 °C a +90 °C.

Temperatura ambiente hasta 40 °C.

Altura de aspiración manométrica hasta 7 metros.

Presión final máxima admitida en el cuerpo de la bomba 10 bar (16 bar para NM4 40/16,20; NM4 50/16; N4M 65/16,20,25; NM4 80/16).

Servicio continuo.

## Motor

Motor a inducción a 4 polos, 60 Hz (n = 1750 1/min).

**NM4, NMS4:** trifásico 220/380 V, 220/440 V, hasta 3 kW;  
380/660 V, de 4 a 75 kW.

Aislamiento clase F.

Protección IP 54 (IP 55 para NMS4).

Motor preparado al funcionamiento con convertidor de frecuencia de 1,1 kW.

**Clase eficiencia IE3 para motor trifásico de 0,75 kW.**

Ejecución según EN 60034-1; EN 60034-30-1.

## Otras ejecuciones bajo demanda

Otras tensiones.

Protección IP 55.

Sello mecánico especial.

Para líquidos o ambientes con temperaturas más elevadas o más bajas.

Motor preparado al funcionamiento con convertidor de frecuencia hasta 0,75 kW.

## Materiales

Componentes	NM4, NMS4	B-NM4, B-NMS4
Cuerpo bomba Acoplamiento NM4 Tapa del cuerpo para NMS4	Hierro GJL 200 EN 1561	Bronce G-Cu Sn 10 EN 1982
Acoplamiento NMS4	Hierro GJL 200 EN 1561	
Rodete	Hierro GJL 200 EN 1561	Bronce G-Cu Sn 10 EN 1982
	Latón P- Cu Zn 40 Pb 2 UNI 5705 Para NM4 25/12 - 25/160 - 25/200, 32/16 - 32/20 - 40/20	
Eje	AISI 303 hasta 1,1 kW	Acero al Cr Ni Mo
	AISI 430 de 1,5 kW a 75 kW	AISI 316
Sello mecánico	Carbón - Cerámica - NBR	
Contrabridas	Acero Fe 430B UNI 7070	

## Pumps with frequency converter

The **NM4 EI** pumps are available with power from 0,25 kW up to 15 kW, the pumps are equipped with **I-MAT** installed on board which allows to realize a variable-speed system extremely compact and efficient, ideal in applications of water supply and in the distribution of hot and cold water.

The pump is equipped with transducers suitable for operation and is already programmed at the factory.

### Advantages

- Energy saving
- Compact design
- Easy to use
- Programmable to suit the system requirements
- Reliability

### Costruction

The system comprises of:

- Pump
- Induction motor
- I-MAT Frequency converter
- Motor adapter for the motor mounting of the frequency converter
- Connection cable between frequency converter and induction motor
- Transducers

### Main features

Rated motor power output from 0,25 kW to 15 kW

Control range from 870 to 1750 rpm (4-pole)

Protection against dry running

Protection against operations with closed valve ports

Protection against system leakages

Protection against overcurrent in the motor

Protection against overvoltage and undervoltage of the power supply

Protection against current unbalances between phases



## Bomba a velocidad variable

La bomba **NM4 EI** se encuentra disponible con potencias de 0,25 kW a 15 kW y llevan incorporado un variador **I-MAT** que permite realizar un sistema de velocidad variable extremadamente compacto y eficiente, ideal para aplicaciones de abastecimiento de agua y la distribución de agua fría y caliente.

Bomba eléctrica es suministrada con un transductor de presión idóneo para el modo operación que escoja el cliente y programado directamente desde fábrica

### Ventajas

- Ahorro de energía
- Diseño compacto
- Fácil de usar
- Programable para las necesidades del sistema
- Fiabilidad

### Construcción

- El sistema está compuesto por:

- Bomba
- Motor de inducción
- I-MAT variador de frecuencia
- Adaptador del motor para el montaje del variador de frecuencia
- Cable de conexión entre en variador y la bomba eléctrica
- Transductores

### Límites de utilización

Potencia nominal del motor desde 0,25 kW hasta 15 kW

Rango de control desde 870 hasta 1750 rpm (4 polos)

Protección contra el funcionamiento en seco

Protección contra el funcionamiento con válvula cerrada

Protección contra fugas del sistema

Protección contra sobrecorriente del motor

Protección contra sobrevoltaje o bajovoltaje de la red de alimentación

Protección contra el desequilibrio de fases

## Operating modes



**Constant pressure mode**  
with pressure transducer

In this mode, the system maintains the preset pressure when the flow required by the installation changes.

## Modos de operación

**Modo presión constante**  
con sensor de presión

En el modo de presión constante, el sistema mantiene la presión prefijada cuando cambia el caudal por los cambios de la instalación.

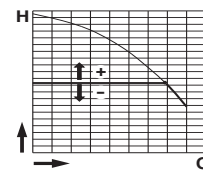

**Proportional pressure mode**  
with pressure transducer

In this mode the system changes the working pressure according to the required flow rate.

**Modo presión proporcional**  
con sensor de presión

En el modo de presión proporcional, el sistema cambia la presión de trabajo de acuerdo al caudal requerido.

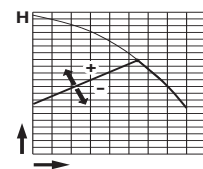

**Constant flow mode**  
with flow meter

In this mode the system maintains a constant flow rate value in a point of the installation according to the required pressure.

**Modo caudal constante**  
con medidor de caudal

En el modo caudal constante el sistema mantiene el caudal constante en un punto de la instalación de acuerdo a la presión requerida.

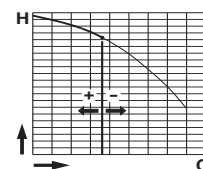

**Fixed speed mode**  
with setting of the speed preferential rotation.

In this mode, by changing the working frequency, you may choose any operational curve included within the working range.

**Modo velocidad fija**  
con el ajuste de la velocidad de rotación preferencial

En el modo velocidad fija, cambiando la frecuencia de trabajo, se puede escoger cualquier curva operativa dentro del rango de trabajo de la bomba.

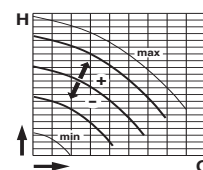

**Constant temperature mode**  
with temperature transducer

In this mode the system keeps the temperature constant inside a system by changing the speed of the pump.

**Modo temperatura constante**  
con sensor de temperatura

En este modo el sistema mantiene la temperatura constante dentro de un sistema cambiando la velocidad de la bomba.

## Performance - Prestaciones

n ≈ 1750 rpm

B - NM4	NM4	P <sub>2</sub>		Q m³/h	Flow (l/min)																		
		kW	HP		1	1,2	1,5	1,89	2,4	3	3,6	4,2	4,8	5,4	6	6,6	7,5	8,4	9,6	10,8	12	13,2	15
					16	20	25	31,5	40	50	60	70	80	90	100	110	125	140	160	180	200	220	250
B-NM4 25/160BE-60	NM4 25/160BE-60	0,25	0,34	H	6,25	6,2	6,1	6,1	6	5,7	5,4	5	4,6	4,1	3,6								
B-NM4 25/160AE-60	NM4 25/160AE-60	0,37	0,5	m	7,95	7,9	7,85	7,8	7,7	7,5	7,2	6,9	6,5	5,8	5								
B-NM4 25/200C-60/A	NM4 25/200C-60/A	0,37	0,5		9,9	9,9	9,8	9,75	9,7	9,4	9,3	9	8,5	8	7,2	6,5							
B-NM4 25/200B-60/A	NM4 25/200B-60/A	0,55	0,75		11,8	11,8	11,8	11,7	11,6	11,5	11,3	11,1	10,9	10,5	10,1	9,7	8,8	7,7	5,9	3,7			
B-NM4 25/200A-60/C	NM4 25/200A-60/C	0,75	1		15,4	15,4	15,3	15,3	15,2	15,1	14,9	14,8	14,5	14,3	14	13,7	13,1	12,3	11	9,2	6,8		
					19,1	19,1	19,1	19	18,9	18,8	18,7	18,6	18,4	18,2	18	17,7	17,2	16,6	15,6	14,4	12,8	10,3	

B - NM4	NM4	P <sub>2</sub>		Q m³/h	Flow (l/min)																			
		kW	HP		2,4	3	3,6	4,2	4,8	5,4	6	7,5	8,4	9,6	10,8	12	13,2	15	16,8	18,9	21	24	27	30
					40	50	60	70	80	90	100	125	140	160	180	200	220	250	280	315	350	400	450	500
B-NM4 32/16B-60	NM4 32/16BE-60	0,37	0,5	H m	7,6	7,6	7,5	7,4	7,4	7,3	7,1	6,6	6,1	5,3	4,4									
B-NM4 32/16A-60	NM4 32/16AE-60	0,37	0,5		9,2	9,2	9,1	9,1	9	8,8	8,3	7,8	7,2	6,4	5,4*									
B-NM4 32/20B-60	NM4 32/20BE-60	0,55	0,75		13,1	13	12,9	12,8	12,6	12,4	12,2	11,4	10,8	9,8	8,7	7,3*	5,7*							
B-NM4 32/20A-60/B	NM4 32/20A-60/B	0,75	1		14,9	14,8	14,7	14,6	14,5	14,3	14,1	13,6	13,2	12,4	11,4	10*	8,5*							
B-NM4 40/16C-60	NM4 40/16C-60/A	0,37	0,5							6,75	6,75	6,65	6,53	6,35	6,15	5,9	5,53	4,9	4,2	3,2				
B-NM4 40/16B-60	NM4 40/16B-60/A	0,55	0,75							8,1	8,1	8	7,95	7,8	7,6	7,4	7,2	6,75	6,25	5,5	4,6			
B-NM4 40/16A-60/B	NM4 40/16A-60/C	0,75	1							9,7	9,7	9,65	9,6	9,5	9,37	9,2	9	8,7	8,3	7,8	7	5,8		
B-NM4 40/20B-60/B	NM4 40/20B-60/B	1,1	1,5							13,3	13,2	13,1	13	12,7	12,5	12	11,5	10,5	9,5	7,8				
B-NM4 40/20A-60/B	NM4 40/20A-60/B	1,1	1,5							15,3	15,2	15,1	15	14,7	14,5	14	13,7	13	12,2	10,8	9,3			
B-NM4 40/25C-60/C	NM4 40/25C-60/C	1,5	2							18,3	18,2	18,1	18	17,9	17,6	17,3	16,8	15,7	14,2	11,8	8,9	4,4		
B-NM4 40/25B-60/C	NM4 40/25B-60/C	2,2	3							22,7	22,7	22,7	22,6	22,6	22,5	22,3	22,1	21,6	20,6	19,2	17,5	14,2	10,1	
B-NM4 40/25A-60/B	NM4 40/25A-60/B	3	4							25,1	25	25	24,9	24,9	24,8	24,6	24,4	24	23,6	22,6	21,3	18,5	15	10,7*

B - NM4	NM4	P <sub>2</sub>		Q m³/h	Flow (l/min)																			
		kW	HP		10,8	12	13,2	15	16,8	18,9	21	24	27	30	33	37,8	42	48	54	60	66	75	84	96
					180	200	220	250	280	315	350	400	450	500	550	630	700	800	900	1000	1100	1250	1400	1600
B-NM4 50/16B-60/B	NM4 50/16B-60/C	1,1	1,5	H m	9	9	9	8,95	8,8	8,55	8,25	7,7	7	6,25	5,4	3,8*								
B-NM4 50/16A-60/B	NM4 50/16A-60/C	1,1	1,5		10,5	10,6	10,6	10,6	10,5	10,3	9,9	9,3	8,6	7,9	6,6*	5,3*								
	NM4 50/20C-60/C	1,1	1,5		11,2	11,2	11,1	11	10,8	10,4	10	9,1	8	6,8	5,3	2,7								
	NM4 50/20B-60/C	1,5	2		12,8	12,8	12,8	12,75	12,6	12,3	11,9	11,3	10,5	9,4	8,1	5,8	3,4							
	NM4 50/20A-60/C	2,2	3		16,7	16,8	16,9	16,9	16,8	16,6	16,3	15,74	15,2	14,4	13	11,2	8,5	5,4						
B-NM4 50/25C-60/C	NM4 50/25C-60/C	2,2	3		18,9	18,9	18,9	18,8	18,5	18,2	17,8	17,1	16,2	15,1	13,3	10,3	7,2*							
B-NM4 50/25B-60/B	NM4 50/25B-60/B	3	4		23,1	23,1	23,1	23	22,8	22,6	22,2	21,5	20,5	19,5	18,2	15,3	12*							
B-NM4 50/25A-60/B	NM4 50/25A-60/B	4	5,5		24,1	24,1	24,1	24	23,8	23,6	23,2	22,6	21,9	21	19,7	17	14*							
B-NM4 65/16C-60/C	NM4 65/16C-60/C	1,1	1,5							6,2	6,2	6,1	6,1	6	5,9	5,7	5,4	4,9	4,3					
B-NM4 65/16B-60/C	NM4 65/16B-60/C	1,1	1,5							7,2	7,1	7,1	7	6,9	6,8	6,6	6,3	5,8	5,3	4,6				
B-NM4 65/16A-60/C	NM4 65/16A-60/C	1,5	2							8,9	8,9	8,9	8,8	8,8	8,7	8,6	8,3	7,9	7,5	6,9	5,7			
B-NM4 65/16S-60/A	NM4 65/16S-60/A	2,2	3							10,3	10,3	10,3	10,3	10,3	10,2	10,1	9,9	9,6	9,1	8,6	7,6	6,2		
B-NM4 65/20B-60/A	NM4 65/20B-60/A	2,2	3							12,2	12,2	12,2	12,1	12,1	11,9	11,6	11,2	10,6	9,9	9,1	7,7	6	3,2	
B-NM4 65/20A-60/A	NM4 65/20A-60/B	3	4						14,6	14,6	14,6	14,6	14,4	14,3	13,9	13,4	12,9	12,1	10,8	9,3	6,8			
B-NM4 65/25B-60/B	NM4 65/25B-60/B	4	5,5						19,6	19,6	19,7	19,7	19,6	19,4	19,2	18,6	17,8	16,8	15,6	13,5	10,9	7,1		
B-NMS 65/25A-60/C	NM4 65/25A-60/C	5,5	7,5						23,8	24	24	24,1	24,1	24	23,9	23,5	22,9	22,1	21,2	19,4	17,2	13,7		
B-NM4 65/31C-60	NM4 65/31C-60/B	5,5	7,5						27	27	26,5	26	25,5	25	24,5	23,5	22	20*	17*	13*				
B-NM4 65/31B-60	NM4 65/31B-60/B	7,5	10						32	32	31,5	31	31	30,5	30	29,5	29	28	26,5*	24*	20,5*			
B-NM4 65/31A-60	NM4 65/31A-60/B	9,2	12,5						36	36	35,5	35	35	34,5	34	33,5	33	32	31*	29*	26,5*			

B-NMS4	NM4	P <sub>2</sub>		Q m³/h	Flow (l/min)																			
		kW	HP		30	33	37,8	42	48	54	60	66	75	84	96	108	120	132	150	168	180	192	210	
					500	550	630	700	800	900	1000	1100	1250	1400	1600	1800	2000	2200	2500	2800	3000	3200	3500	
B-NM4 80/20C-60	NM4 80/20C-60/B	2,2	3	H m	10,9	10,8	10,7	10,6	10,5	10,3	10	9,7	9,1	8,2	6,7									
B-NM4 80/20B-60	NM4 80/20B-60/A	3	4		12,5	12,5	12,4	12,3	12,1	12	11,7	11,4	10,6	9,8	8,5	6,5*								
B-NM4 80/20A-60	NM4 80/20A-60/A	4	5,5		14,2	14,1	14	14	13,9	13,8	13,5	13,4	12,8	12	11	9,2*	7,4*							
B-NM4 80/25C-60	NM4 80/25C-60/A	4	5,5		17,4	17,3	17,1	17	16,6	16,1	15,8	15,2	14,1	13	11,3	9,5*								
B-NMS4 80/250B-60/A	NM4 80/25B-60/B	5,5	7,5		20,8	20,8	20,7	20,7	20,5	20,1	19,8	19,4	18,3	17,3	15,7	13,8*	11,5*							
B-NMS4 80/250A-60/A	NM4 80/25A-60/B	7,5	10		24,2	24,2	24,1	24	24	23,9	23,4	23	22	21,1	19,4	17,5*	15,2*	12,7*						
B-NM4 80/31C-60	NM4 80/31C-60/B	9,2	12,5		26,2	26,2	26,2	26,2	26,1	26	25,8	25,5	24,9	24,1	22,7	21	18,8	16,2						
B-NMS4 80/315B-60/B	NM4 80/31B-60	11	15		31,1	31,2	31,3	31,3	31,3	31,2	31	30,8	30,2	29,5	28,1	26,3	24,2	21,8	17,5					
B-NMS4 80/315A-60/B	NM4 80/31A-60	15	20		36,9	37,1	37,2	37,3	37,4	37,4	37,4	37,4	36,7	36	34,8	33,2	31,2	29	25,1	20,6				
B-NMS4 80/315S-60	NMS4 80/315S-60	18,5	25		42,3	42,5	42,7	42,9	43,1	43,2	43,2	43	42,7	42,1	41	39,5	37,8	35,8	32,3	28				
B-NMS4 80/400C-60/B	NMS4 80/400C-60/B	18,5	25		47,2	47,3	47,3	47,3	47,3	47,1	46,8	46,3	45,4	44,1	41,9	39	35,4	31,3						
B-NMS4 80/400B-60/B	NMS4 80/400B-60/B	22	30		52,1	52,1	52,2																	



## Performance - Prestaciones

n ≈ 1750 rpm

B-NMS4	NM4	P <sub>2</sub>		Q m <sup>3</sup> /h l/min	H m																			
		kW	HP		48	54	60	66	75	84	96	108	120	132	150	168	180	192	210	240	270	300	330	
					800	900	1000	1100	1250	1400	1600	1800	2000	2200	2500	2800	3000	3200	3500	4000	4500	5000	5500	
B-NM4 100/20C-60	NM4 100/20C-60/A	3	4	9,4	9,4	9,2	9,1	8,9	8,5	8	7,2	6,4	5,5	4*										
B-NM4 100/20B-60	NM4 100/20B-60/A	4	5,5	11,7	11,7	11,6	11,5	11,4	11,2	10,8	10	9,2	8,3	6,5*	4,6*									
B-NM4 100/20A-60	NM4 100/20A-60/B	5,5	7,5	14	14	13,9	13,9	13,8	13,7	13,3	12,7	12	11,3	9,8*	8,2*	7*	5,5*							
B-NMS4 100/250B-60	NM4 100/25B-60/B	7,5	10	19,4	19,4	19,3	19,2	19	18,6	18	17,4	16,5	15,5	13,8*	11,5*	10*	8,2*	5,5*						
B-NMS4 100/250A-60	NM4 100/25A-60/B	9,2	12,5	22,4	22,4	22,2	22,1	21,9	21,4	21	20,4	19,6	18,8	17*	15*	13,3*	11,6*	8,8*						
B-NMS4 100/315C-60/A	NM4 100/31C-60	11	15	28	28	27,9	27,9	27,5	27	26	25	23,5	22	19,5*	15,5*	13*	10*							
B-NMS4 100/315B-60/A	NM4 100/31B-60	15	20	32,5	32,5	32,4	32,3	32	31,5	31	30,5	29,5	28,5	26*	22,5*	20*	17,5*	13,5*						
B-NMS4 100/315A-60/A	NMS4 100/315A-60/A	18,5	25	38,5	38,5	38,3	38,3	38	37,9	37,5	37	36	35	32,5*	30*	28*	26*	21*						
B-NMS4 100/400C-60/A	NMS4 100/400C-60/A	22	30	43	42,8	42,5	42,5	42	42	41	40	38,5	37	34*	30,5*	28*								
B-NMS4 100/400B-60/A	NMS4 100/400B-60/A	30	40	51,5	51,3	51	50,8	50,5	50,3	50	49	48	46	44*	41*	39*	37*	33*						
B-NMS4 100/400A-60/A	NMS4 100/400A-60/A	37	50	59,5	59,3	59	58,8	58,5	58,3	58	57,7	57	56	53,5*	51*	49*	47*	44*						

B-NMS4	NM4	P <sub>2</sub>		Q m <sup>3</sup> /h l/min	H m																		
		kW	HP		84	96	108	120	132	150	168	180	192	210	240	270	300	330	360	390	420	450	480
					1400	1600	1800	2000	2200	2500	2800	3000	3200	3500	4000	4500	5000	5500	6000	6500	7000	7500	8000
B-NMS4 125/250E-60	NM4 125/25E-60/B	5,5	7,5	11,2	11	10,7	10,4	10	9,4	8,5	8	7,3	6,2										
B-NMS4 125/250D-60	NM4 125/25D-60/B	7,5	10	14	13,9	13,7	13,4	13	12,4	11,6	11	10,4	9,3	7,3*	5*								
B-NMS4 125/250C-60	NM4 125/25C-60/B	9,2	12,5	16,8	16,6	16,4	16,1	15,8	15,2	14,6	14	13,3	12,3	10,3*	8*	5,4*							
B-NMS4 125/250B-60/A	NM4 125/25B-60	11	15	19,4	19,2	19	18,8	18,6	18	17,4	17	16,3	15,2	13,2*	10,8*	8*							
B-NMS4 125/250A-60/A	NM4 125/25A-60	15	20	23	22,9	22,8	22,7	22,5	22	21,5	20,9	20,3	19,2	17,2*	14,9*	12,2*	9*						
B-NMS4 125/315C-60/A	NMS4 125/315C-60/A	18,5	25	28	27,8	27,5	27,3	27	26,5	25,5	25	24	23	20*	17*	13*							
B-NMS4 125/315B-60/A	NMS4 125/315B-60/A	22	30	32	31,7	31,5	31	30,8	30,5	29,5	29	28,5	27	25*	22*	18,5*	14,5*						
B-NMS4 125/315A-60/A	NMS4 125/315A-60/A	30	40	37	36,7	36,5	36	35,8	35,5	35	34,5	34	32,5	30,5*	28*	25*	21,5*						
B-NMS4 125/400C-60/A	NMS4 125/400C-60/A	37	50	45,5	45	44,8	44,6	44,5	44,3	43,5	43	42	40	36,5*	32,5*	28*							
B-NMS4 125/400B-60/A	NMS4 125/400B-60/A	45	60	51,7	51,5	51,3	51	50,7	50	49,5	49	48	46,5	43,5*	40*	35,5*	31*						
B-NMS4 125/400A-60/A	NMS4 125/400A-60/A	55	75	59,5	59,3	59	58,8	58,7	58	57,5	57	56,5	55,5	53*	50*	46*	41,5*						
B-NMS4 150/315D-60/A	NMS4 150/315D-60/A	18,5	25					22,8	22,6	22,3	22	21,8	21,2	20	18,5	16,7	14,7	12,4	10*	7,4*			
B-NMS4 150/315C-60/A	NMS4 150/315C-60/A	22	30					25,8	25,6	25,4	25,2	24,9	24,4	23,2	21,9	20,2	18,4	16,2	14*	11,4*			
B-NMS4 150/315B-60/A	NMS4 150/315B-60/A	30	40					30,5	30,4	30,2	30,1	30	29,8	29	27,9	26,5	24,8	22,8	20,7*	18,2*	15,4*		
B-NMS4 150/315A-60/A	NMS4 150/315A-60/A	37	50					35,6	35,5	35,4	35,3	35,2	35	34,4	33,7	32,5	30,9	29	26,8*	24,4*	21,8*		
B-NMS4 150/400C-60/A	NMS4 150/400C-60/A	45	60					45,5	45	44,5	44	43,8	43,5	42	40,5	38,5	36	33	30*	27*			
B-NMS4 150/400B-60/A	NMS4 150/400B-60/A	55	75					51	50,5	50	49,5	49,3	49	48	46,5	44,5	42,5	40	37,5*	34,5*	31,5*		
B-NMS4 150/400A-60/A	NMS4 150/400A-60/A	75	100					59	58,5	58,3	58	57,8	57,5	57	55,5	54	52	49,5	47*	44*	41*	37,5*	

**NM4, NMS4** Standard construction.  
Ejecución normal.

**P<sub>2</sub>** Rated motor power output.  
Potencia nominal del motor.

\* Maximum suction lift 1-2 m.  
Altura máxima de aspiración manométrica 1-2 m.

**B-NM4, B-NMS4** Bronze construction.  
Ejecución en bronce.

**H** Total head in m.  
Altura total en m.

Tolerances according to UNI EN ISO 9906:2012.  
Tolerancias según UNI EN ISO 9906:2012.

## Rated currents - Intensidades nominales

P <sub>2</sub>		P <sub>2</sub> *	SF	220V Δ / 380V Y			220V Δ / 440V Y		440V Δ	I <sub>A</sub> /I <sub>N</sub>
kW	HP			kW	IN A	IN A	IN A	IN A		
0,25	0,34	0,28	1,15	1,7	1		1,8	1,1		3,5
0,37	0,5	0,43	1,15	2	1,1		1,7	1,0		4,1
0,55	0,75	0,63	1,15	3,1	1,8		2,7	1,6		4,5
0,75	1	0,86	1,15	3,8	2,2		4,0	2,3		7,5
1,1	1,5	1,27	1,15	5,8	3,3		6,0	3,5		7,0
1,5	2	1,75	1,15	7	4		7,3	4,2		8,7
2,2	3	2,55	1,15	9,8	5,7		10,4	6,0		9,1
3	4	3,45	1,15	13,5	7,8		14,2	8,2		5,7
4	5,5	4,55	1,15		10,2	5,9				7,0
5,5	7,5	6,3	1,15		15,3	8,7				7,1
7,5	10	8,6	1,15		19,1	11,1				7,1
9,2	12,5	10,6	1,15		22,6	13,2				7,5
11	15	12,6	1,15		26,8	15,5				9,1
15	20	17,3	1,15		34,5	20				9,2
18,5	25	21,3	1,15		42	24,2		36		7,2
22	30	25,3	1,15		49,6	28,5		43		6,9
30	40	34,5	1,15		64,5	37,2		58		7,3
37	50	42,5	1,15		84	48,5		70		6,7
45	60	52	1,15		95,5	55		85		6,3
55	75	63	1,15		120	69		102		6,7
75	100	86	1,15		166	95,5		138		6,8

**P<sub>2</sub>** Rated motor power output.  
Potencia nominal del motor.

\* Power with S.F.  
Potencia con S.F.

I<sub>A</sub>/I<sub>N</sub> D.O.L. starting current / Rated current  
Intensidad de arranque / Intensidad nominal

Rated power on the nameplate  
Potencia nominal de la placa de identificación

## Characteristic curves - Curvas Características

n ≈ 1750 rpm

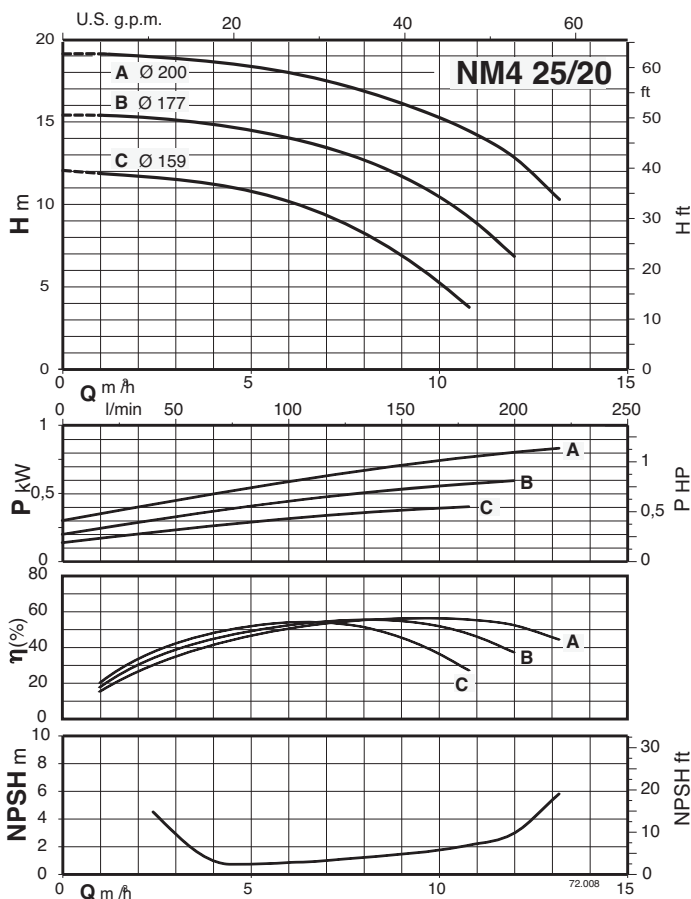
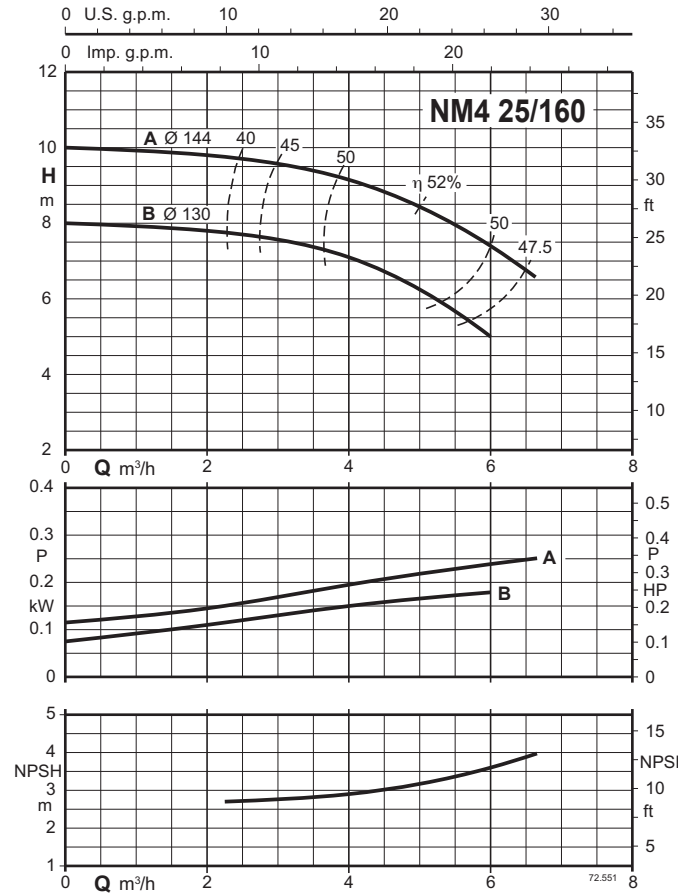
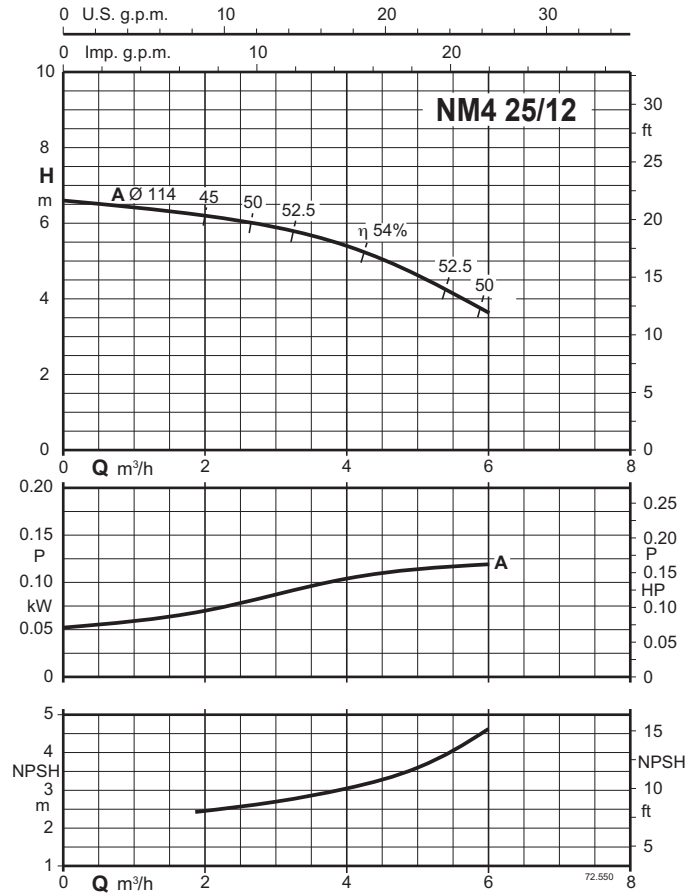

## Characteristic curves - Curvas Características

$n \approx 1750$  rpm

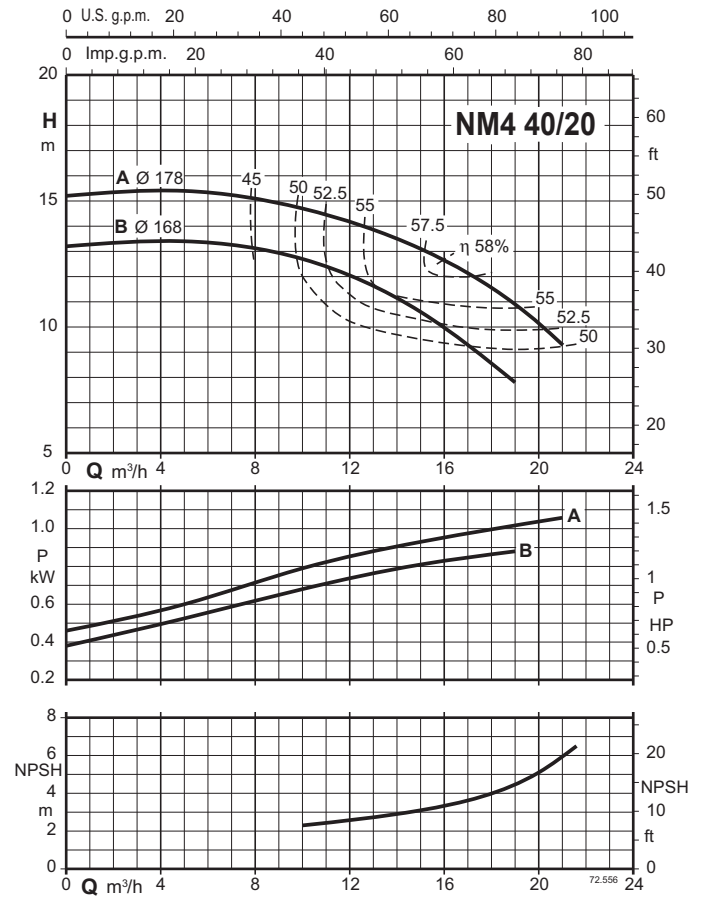
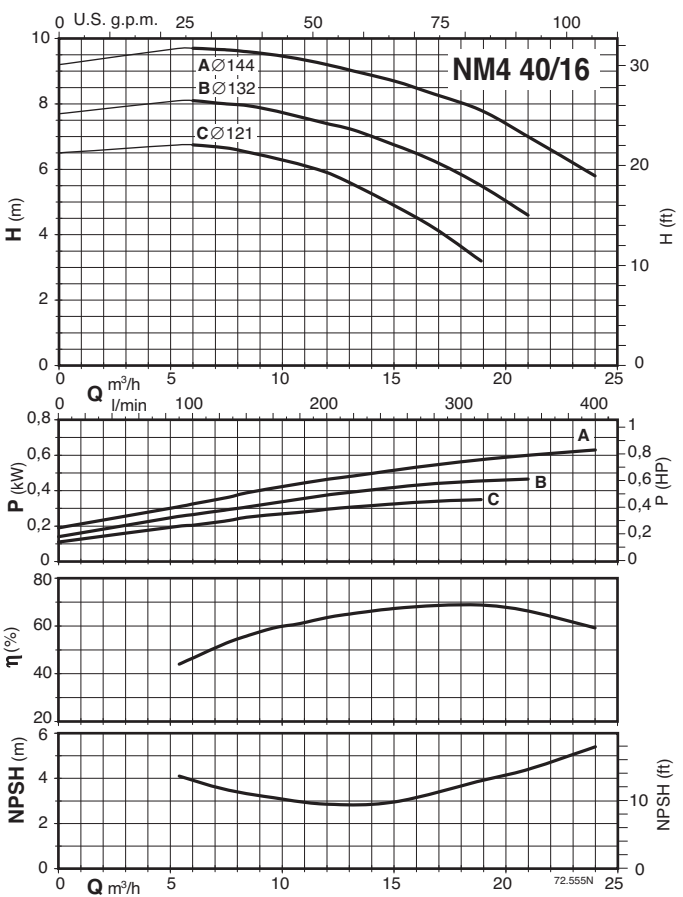
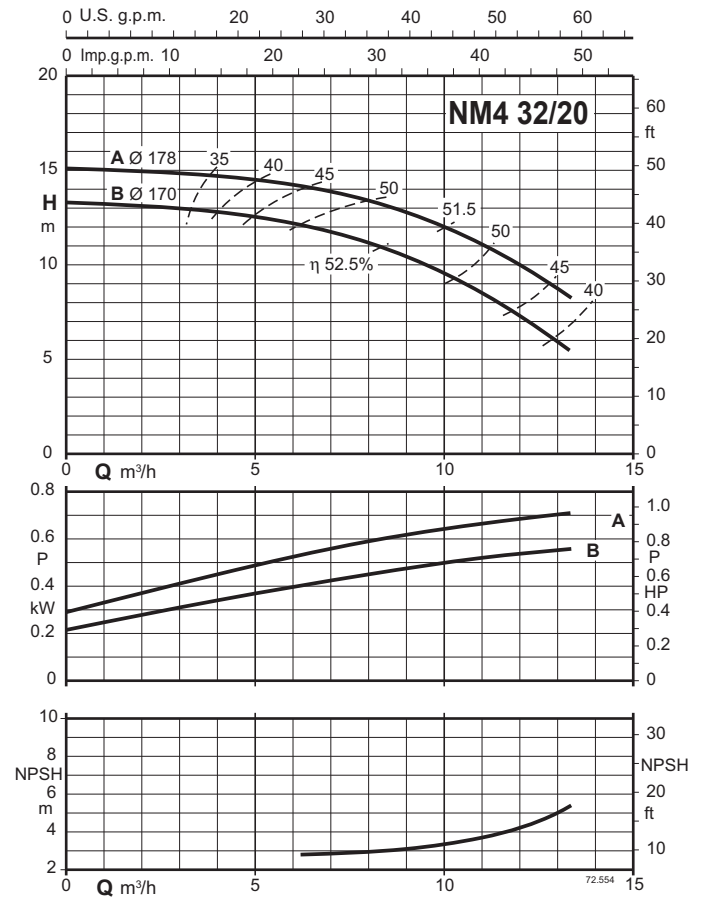
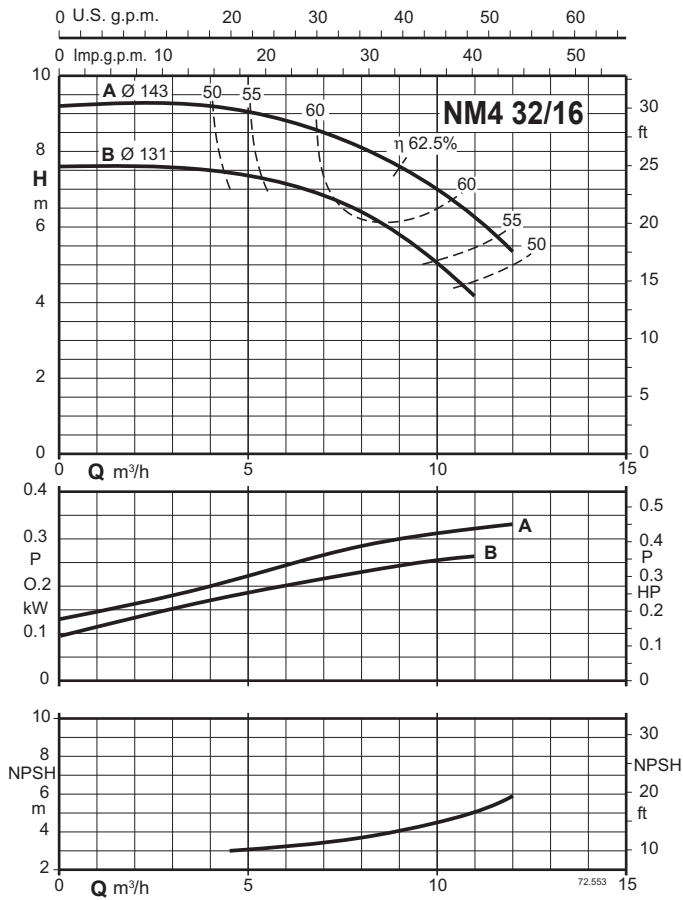

## Characteristic curves - Curvas Características

$n \approx 1750$  rpm

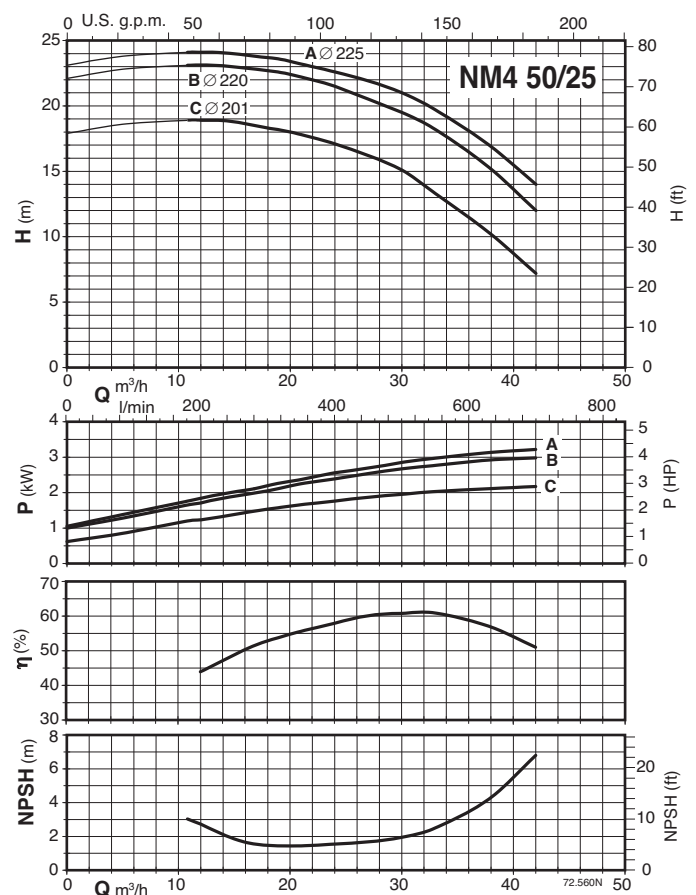
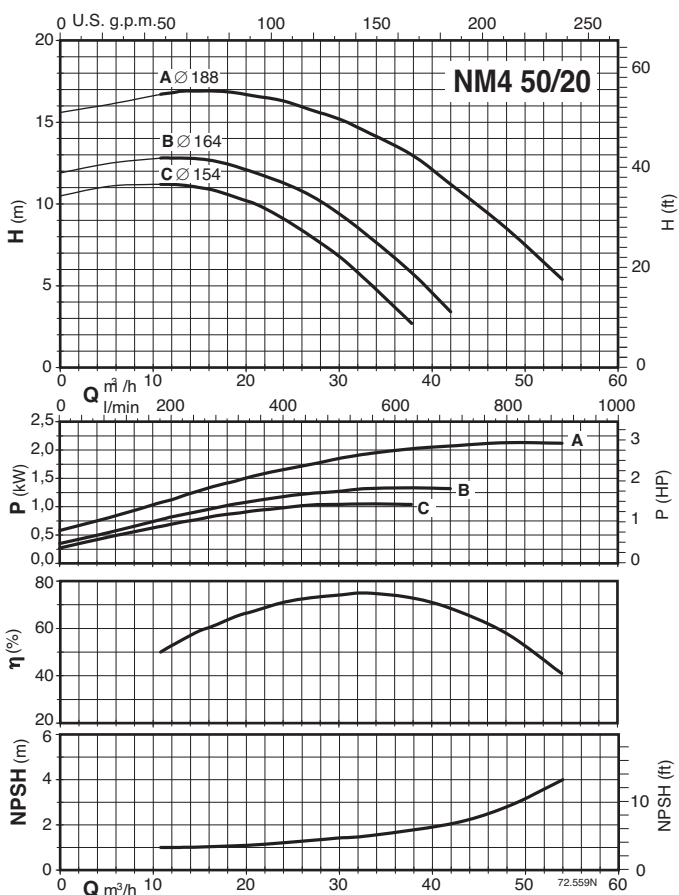
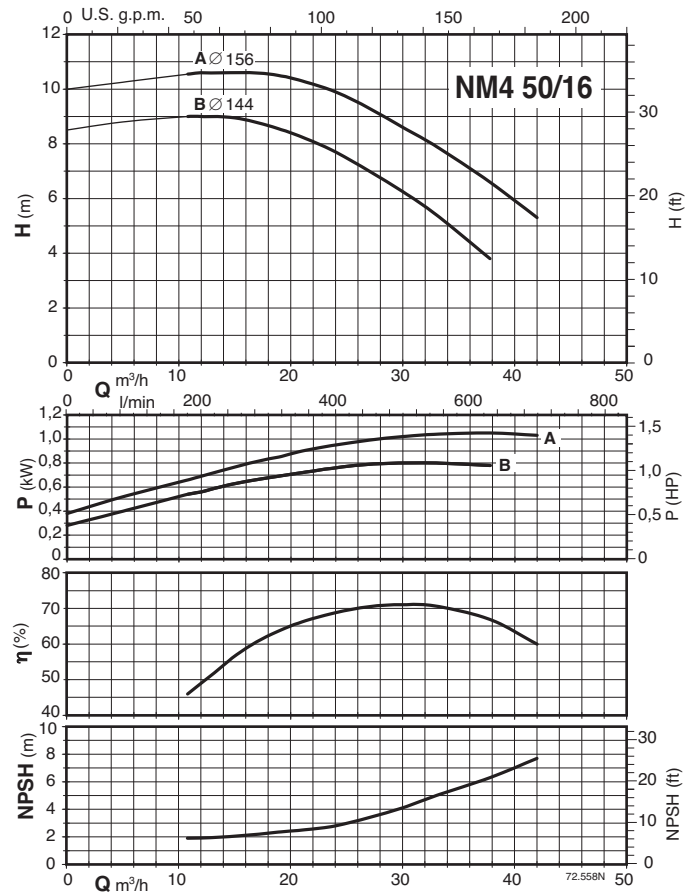
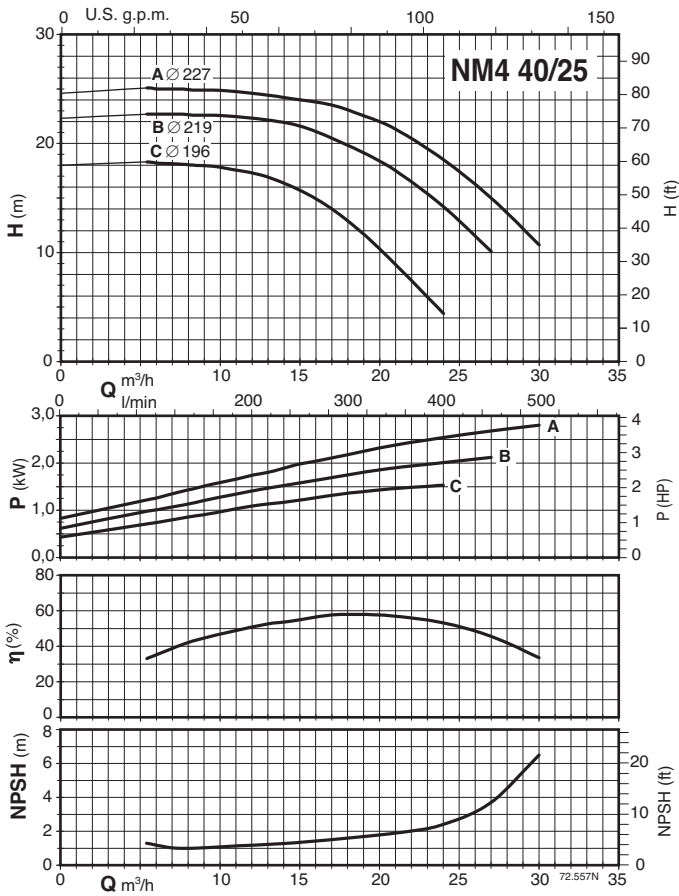



## Characteristic curves - Curvas Características

$n \approx 1750$  rpm

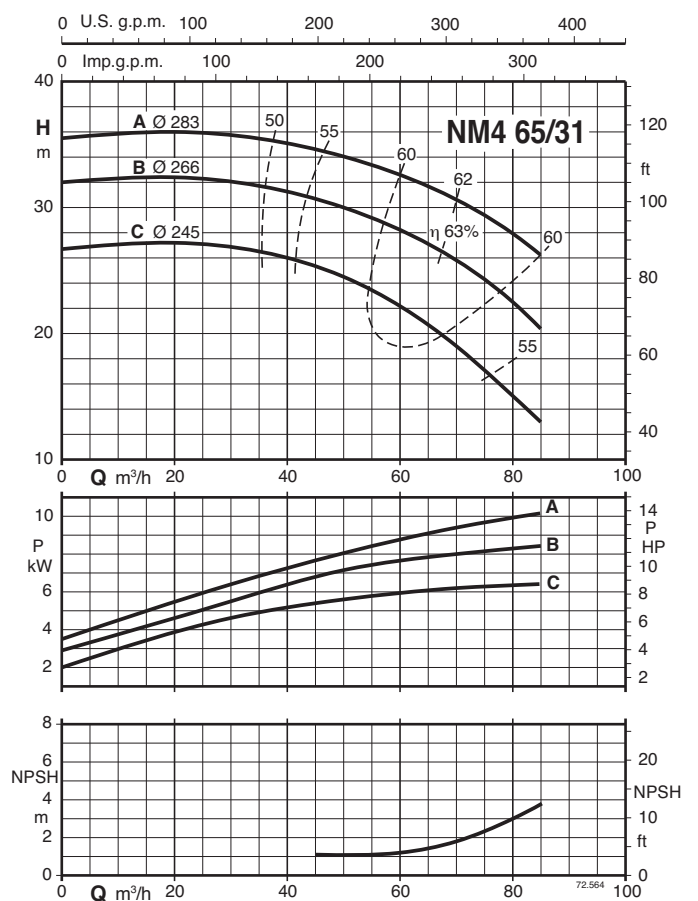
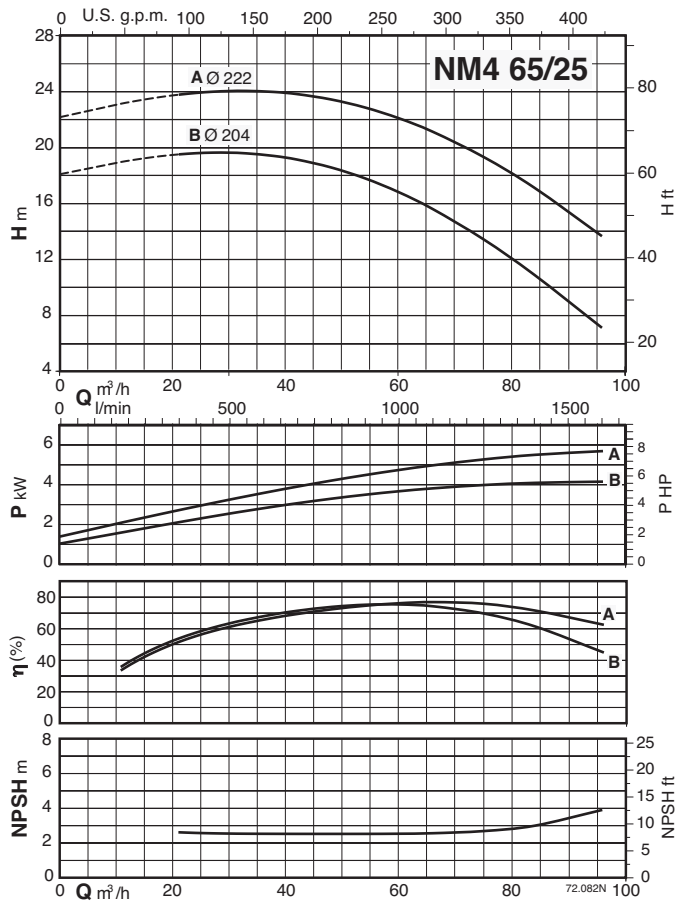
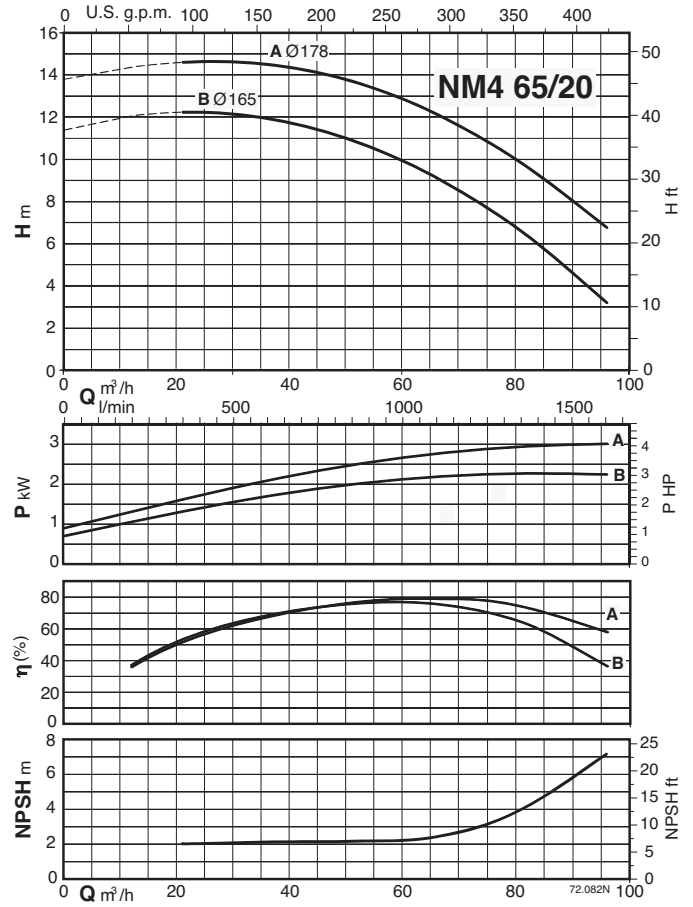
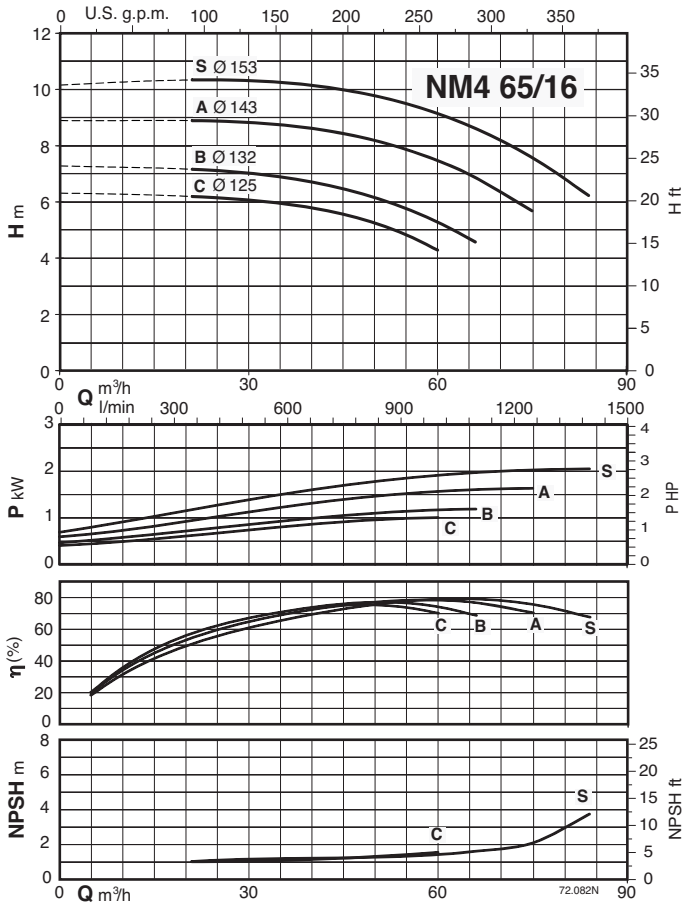

## Characteristic curves - Curvas Características

n ≈ 1750 rpm

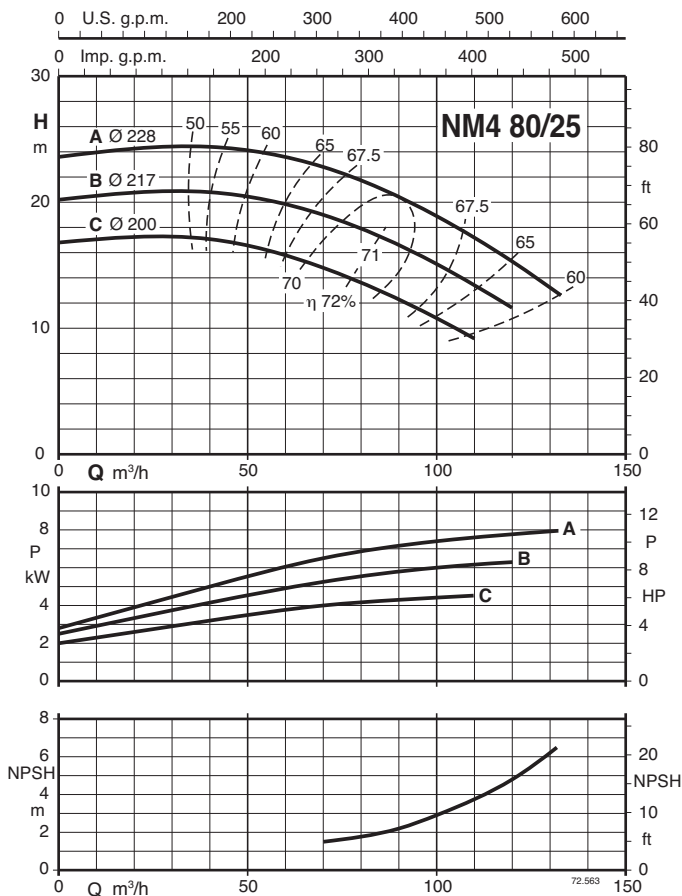
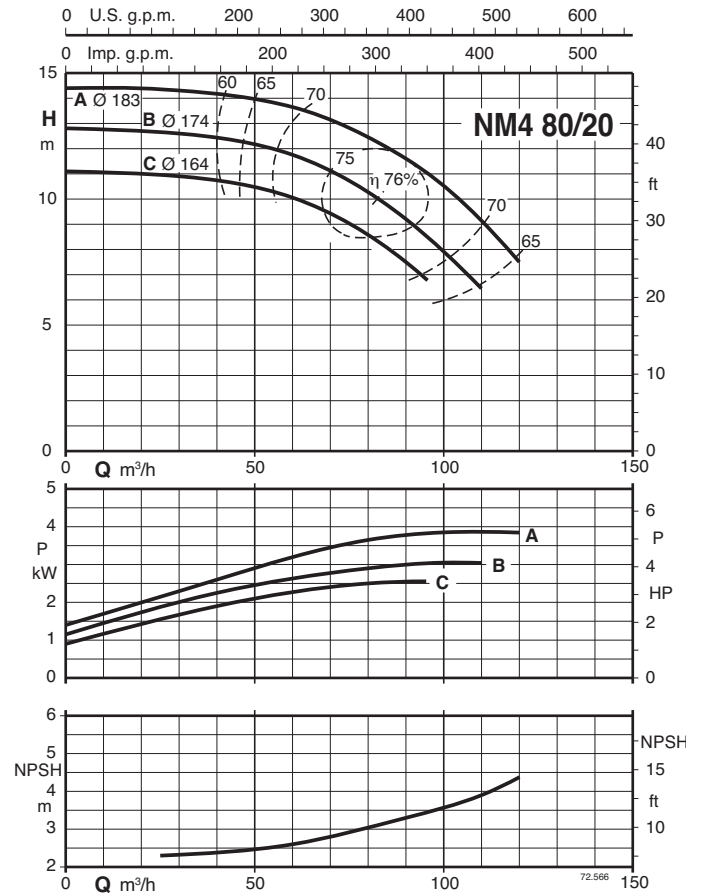
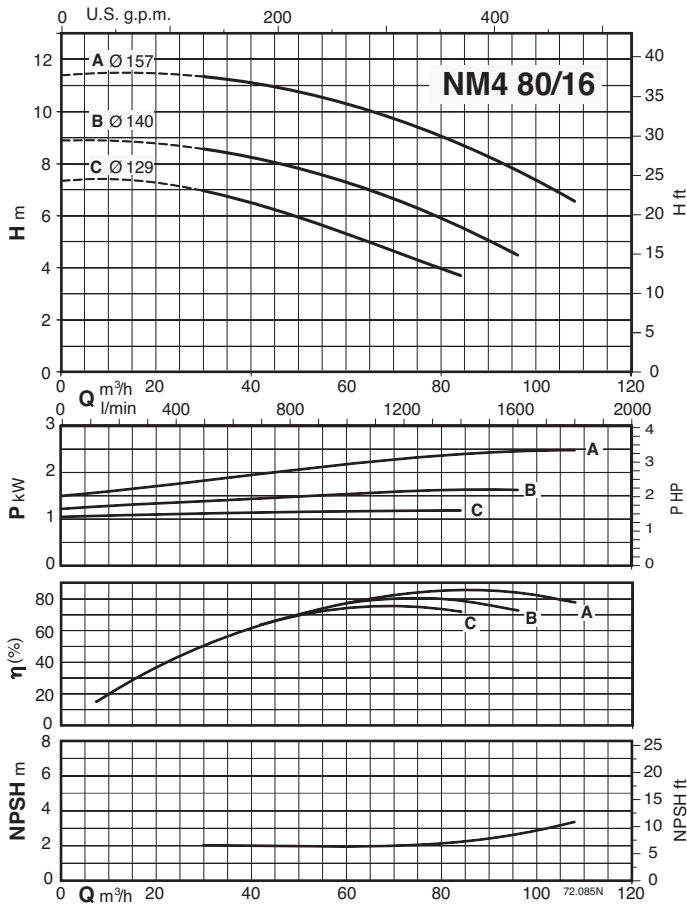

## Characteristic curves - Curvas Características

$n \approx 1750$  rpm

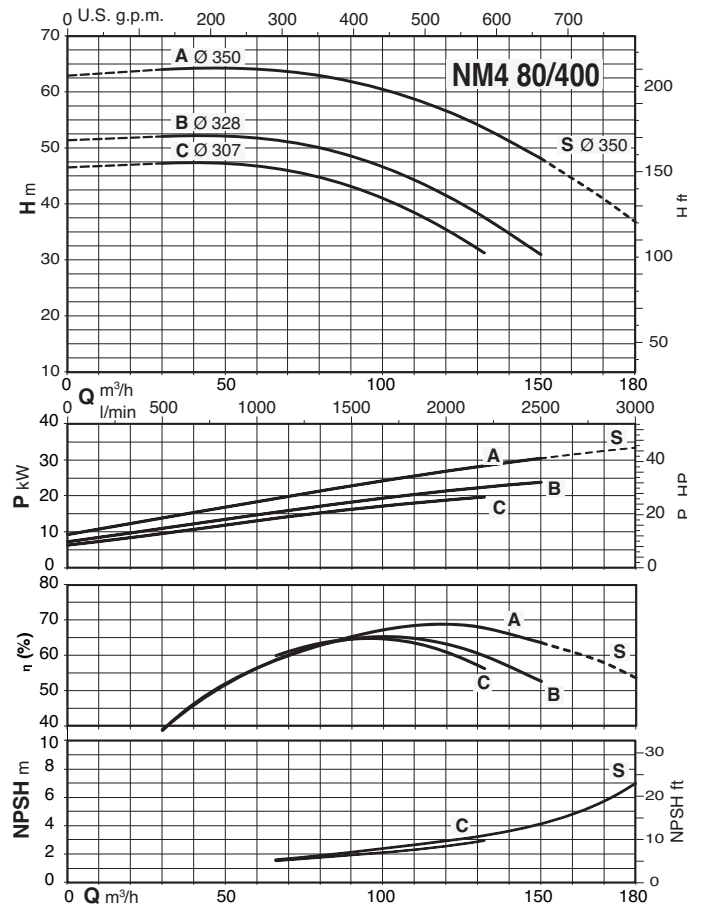
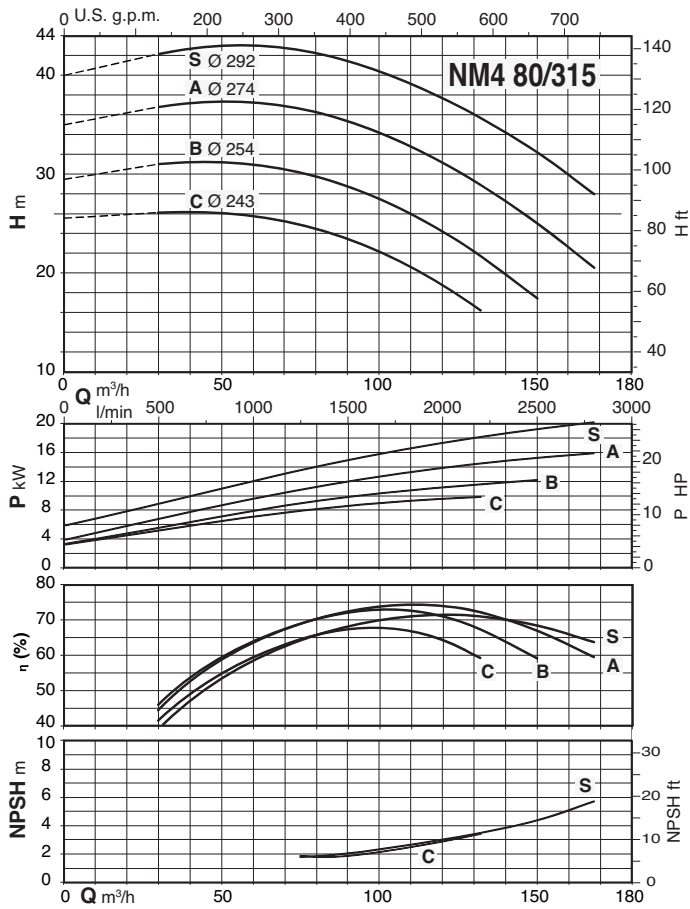

## Characteristic curves - Curvas Características

n ≈ 1750 rpm

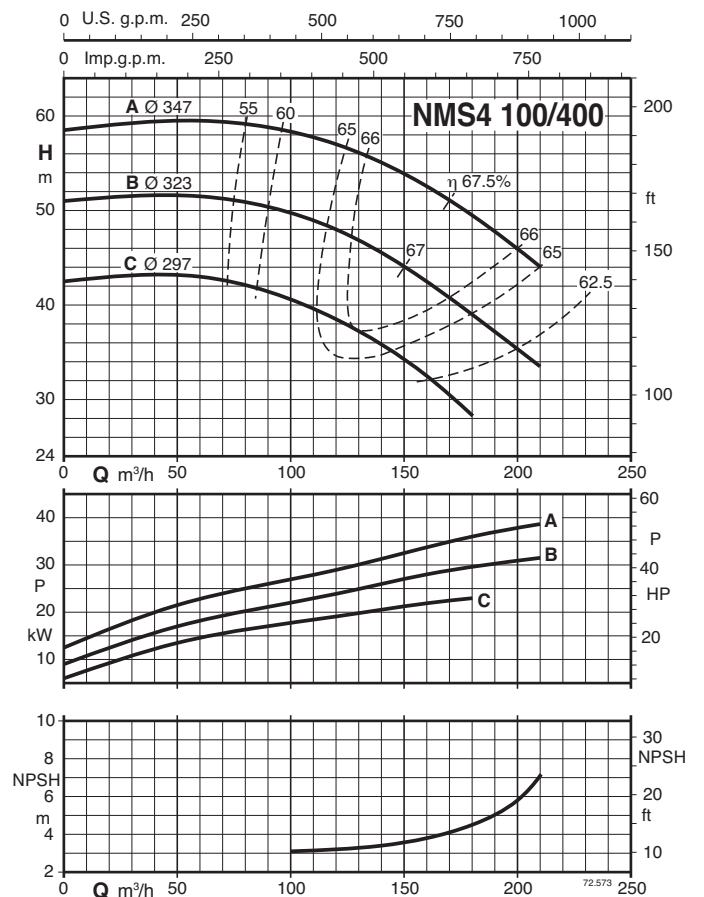
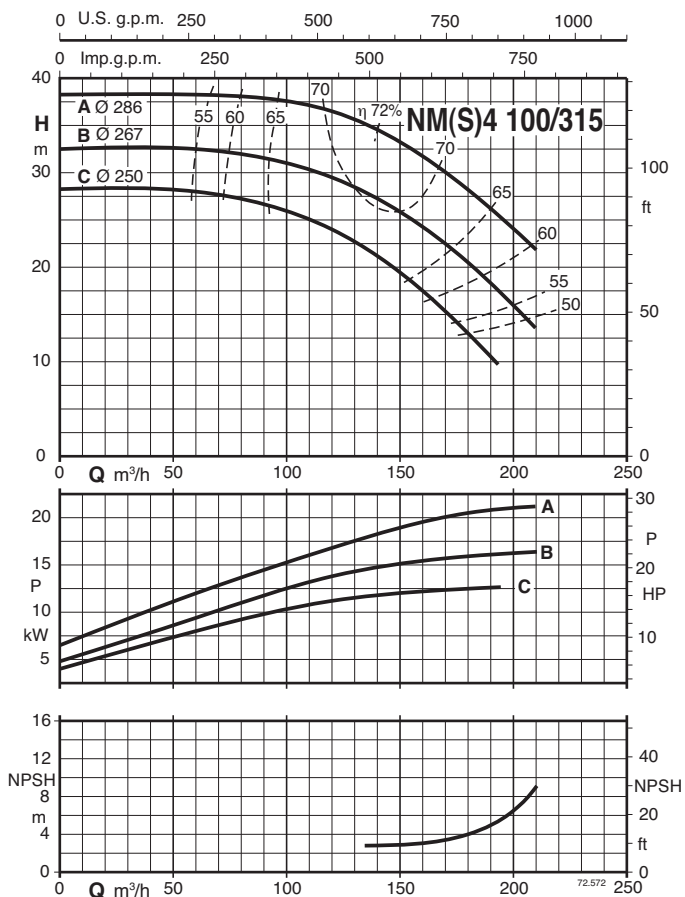
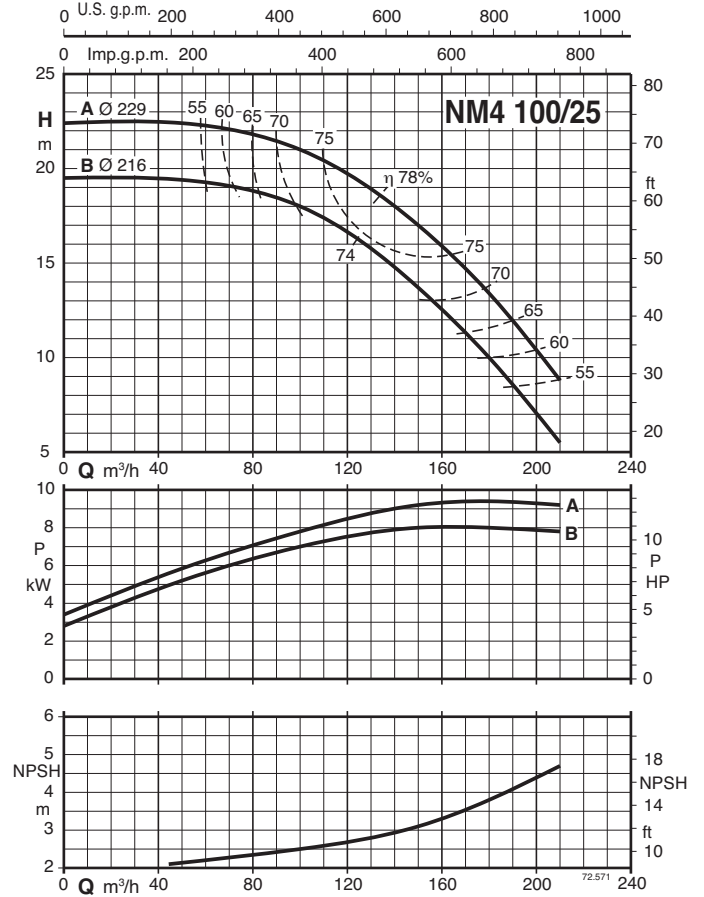
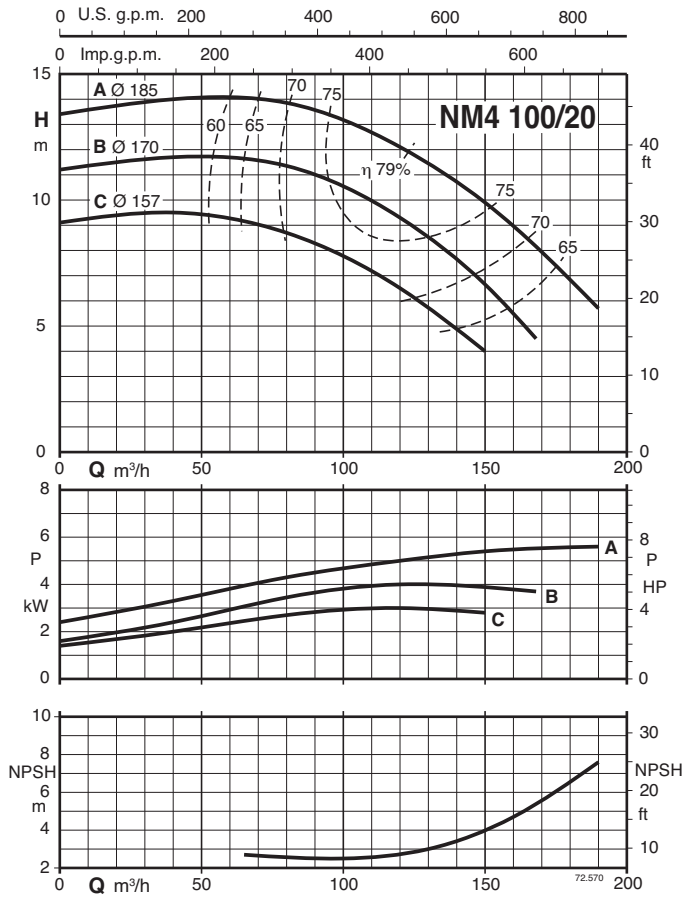

## Characteristic curves - Curvas Características

n ≈ 1750 rpm

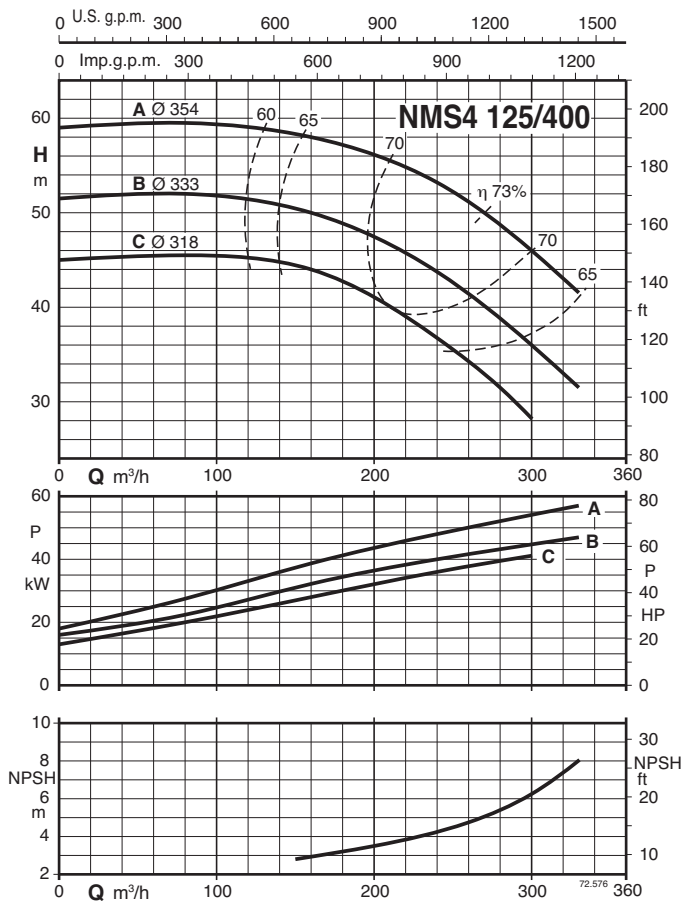
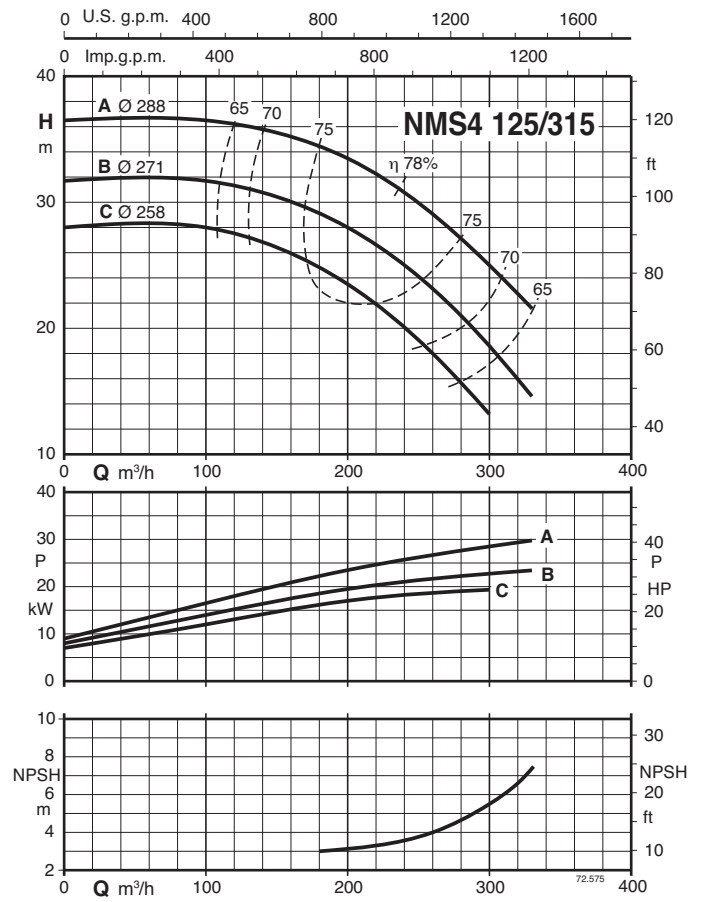
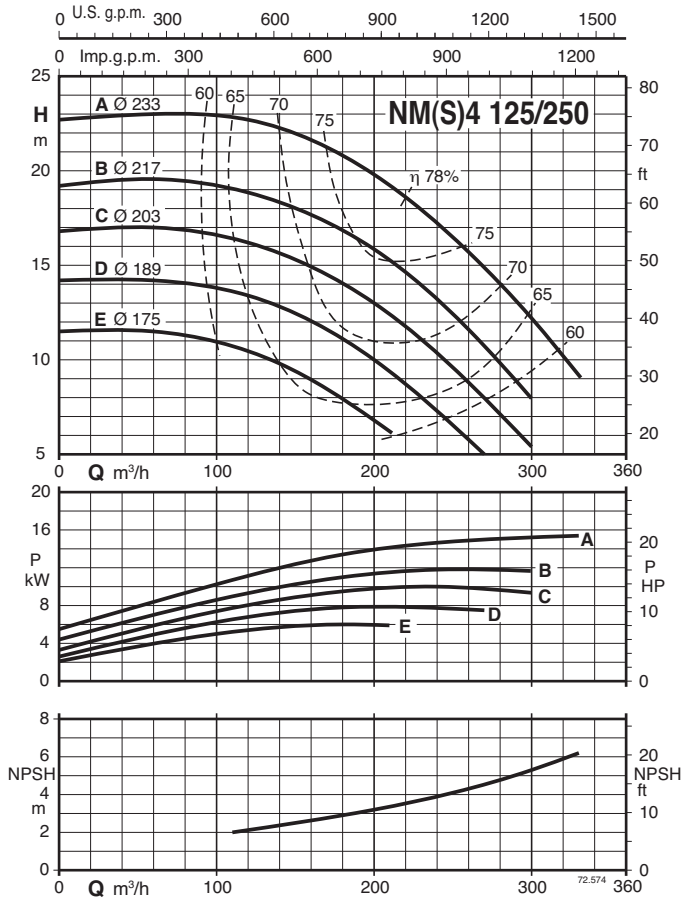



## Characteristic curves - Curvas Características

n ≈ 1750 rpm

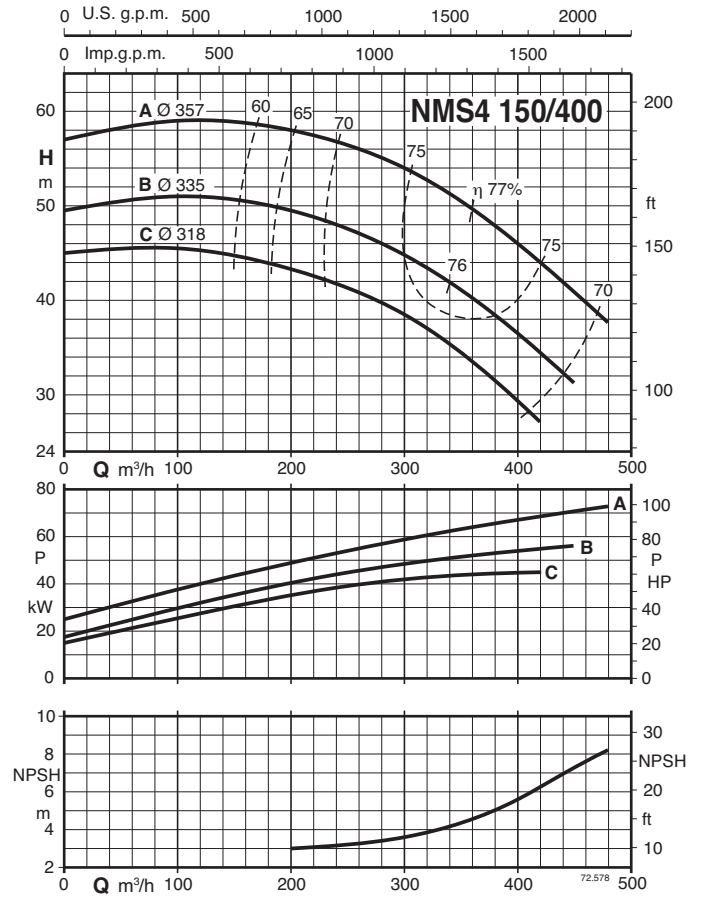
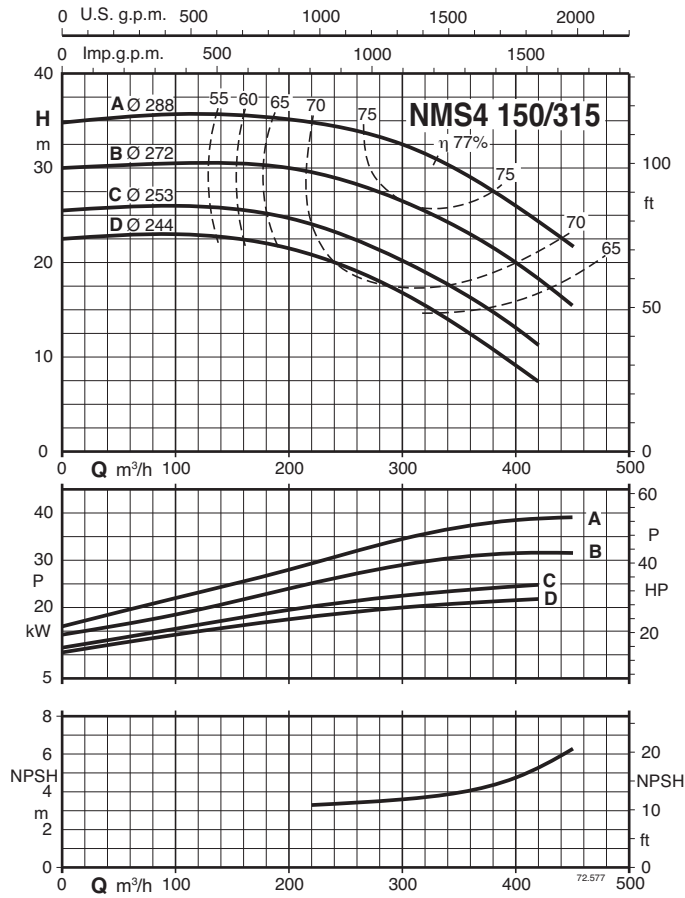

## Dimensions and weights - Dimensiones y pesos

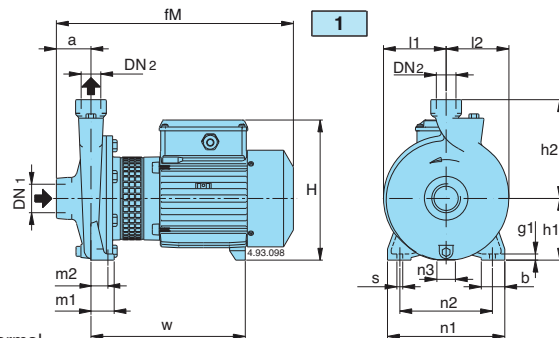

Standard construction - Ejecución normal

✓ NPT Version on demand  
Ejecuciones bajo demanda

Picture Figura	NM4	DN1 ISO 228	DN2 NPT	mm																kg		
				a	fM	h1	h2	H	m1	m2	n1	n2	n3	b	s	l1	l2	w	g			
1	NM4 25/12A-60/A	G 1 1/2	G 1	✓	56	313	90	140	199	37,5	27,5	170	130	9	38	9,5	85	88	250	10	13,5	
	NM4 25/160AE-60-BE-60			✓	56	380	100	160	228	37,5	27,5	190	150	30	38	9,5	102	102	250	10	17,5	
	NM4 25/200B-60/A-C-60/A			✓	63	385	125	180	253	45	32,5	245	200	49	45	11,5	125	125	250	290	11	23-21,5
	NM4 25/200A-60/C			✓	63	425	125	180	253	45	32,5	245	200	49	45	11,5	125	125	250	290	11	27

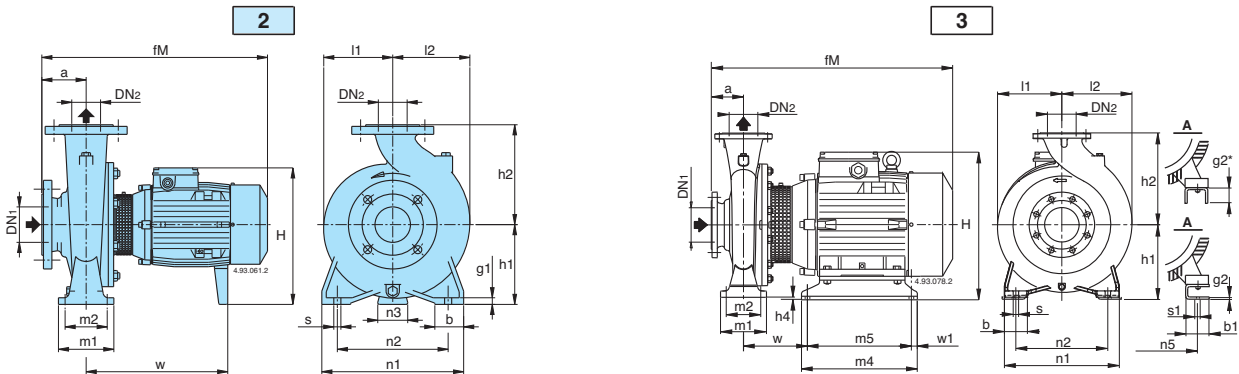

Standard construction - Ejecución normal

Picture Figura	NM4	DN1	DN2	mm																				kg				
				a	fM	h1	h2	H	h4	m1	m2	n1	n2	n3	n5	w1	b	b1	s	s1	l1	l2	w		m4	m5	g1	g2
1	NM4 32/16AE-60-BE-60	50	32	80	410	132	160	260	-	100	70	240	190	47	-	50	-	14	-	120	120	255	-	-	12	-	30,5-30	
	NM4 32/20A-60/A-BE-60	50	32	80	410	160	180	288	-	100	70	240	190	62	-	50	-	14	-	140	140	255	-	-	12	-	38-34,5	
	NM4 40/16A-60/B-B-60/A-C-60/A	65	40	80	410	132	160	268	-	100	70	240	190	47	-	50	-	14	-	119	119	255	-	-	12	-	37-33-31	
	NM4 40/20A-60/A-B-60/A	65	40	100	470	160	180	288	-	100	70	265	212	62	-	50	-	14	-	140	140	255	-	-	12	-	41-40,5	
	NM4 40/25B-60/B-C-60/B	65	40	100	495	180	225	308	-	125	95	320	250	60	-	65	-	14	-	175	175	300	-	-	15	-	66,5-62	
	40/25A-60/B				340			330														78						
	NM4 50/16A-60/B-B-60/B	65	50	100	470	160	180	288	-	100	70	265	212	62	-	50	-	14	-	127	141	255	-	-	12	-	40-39,5	
	NM4 50/20C-60/B	65	50	100	480	160	200	288	-	100	70	265	212	62	-	50	-	14	-	140	153	265	-	-	14	-	44,5	
	50/20A-60/B-B-60/B				60			310						57-52,5														
	NM4 50/25C-60/B-D-60/A	65	50	100	490	180	225	308	-	125	95	320	250	60	-	65	-	14	-	175	175	300	-	-	15	-	68	
	50/25A-60/B-B-60/B				530			340														85,5-78						
	NM4 65/16B-60/B-C-60/B	80	65	100	470	160	200	288	-	125	95	280	212	62	-	65	-	14	-	150	172	255	-	-	15	-	43,5-43	
	65/16A-60/B-S-60				495			300						49,5-55														
	NM4 65/20B-60/C	80	65	100	505	180	225	308	-	125	95	320	250	60	-	65	-	14	-	155	175	310	-	-	15	-	61	
	65/20A-60/B				525			340														73,5						
	NM4 65/25B-60/A	80	65	100	540	200	250	360	-	160	120	360	280	60	-	80	-	18	-	175	190	345	-	-	18	-	97	
	65/25A-60/B				645			405														116						
	NM4 65/31C-60/B	80	65	125	670	225	280	410	-	160	120	400	315	75	-	80	-	18	-	220	220	405	-	-	20	-	164-153	
	65/31A-60/B-B-60/B				745			465														176						
	NM4 80/16C-60/B	100	80	125	495	180	225	288	-	125	95	320	250	62	-	65	-	14	-	165	193	255	-	-	15	-	50,5	
	80/16A-60/B-B-60/B				520			308														59,5-56						
	NM4 80/20C-60/A	100	80	125	540	180	250	308	-	125	95	345	280	60	-	65	-	14	-	170	194	320	-	-	15	-	74,5	
	80/20A-60/A-B-60/A				560			340														82						
	NM4 80/25C-60/A	100	80	125	565	200	280	360	-	160	120	400	315	60	-	80	-	18	-	191	210	335	-	-	20	-	102	
80/25B-60/B	745				335			124																				
80/25A-60/B	745				465			135																				
NM4 80/31C-60/B	100	80	125	745	250	315	435	-	160	120	400	315	90	-	80	-	18	-	220	232	465	-	-	20	-	181		
2	NM4 80/31A-60-B-60	100	80	125	787	260	315	466	10	160	120	400	315	-	254	20	80	74	18	14	220	232	147	435	395	-	6	269-248
1	NM4 100/20B-60/A-C-60/A	125	100	125	565	200	280	360	-	160	120	360	280	60	-	80	-	18	-	180	212	330	-	-	20	-	99-90	
	NM4 100/20A-60/B				665			385														109						
2	NM4 100/25A-60/B-B-60/B	125	100	140	760	225	280	410	-	160	120	400	315	75	-	80	-	18	-	205	233	465	-	-	20	-	152-143	
2	NM4 100/31B-60-C-60	125	100	140	802	260	315	466	10	160	120	400	315	-	254	20	80	74	18	14	230	250	147	435	395	-	6	280-261
1	NM4 125/25E-60/B	150	125	140	685	250	355	435	-	160	120	400	315	90	-	80	-	18	-	235	268	405	-	-	20	-	149	
	NM4 125/25C-60/B-D-60/B				735			465														173-161						
2	NM4 125/25A-60-B-60	150	125	140	802	260	355	466	10	160	120	400	315	-	254	20	80	74	18	14	235	268	147	435	395	-	6	261-243

## Dimensions and weights - Dimensiones y pesos

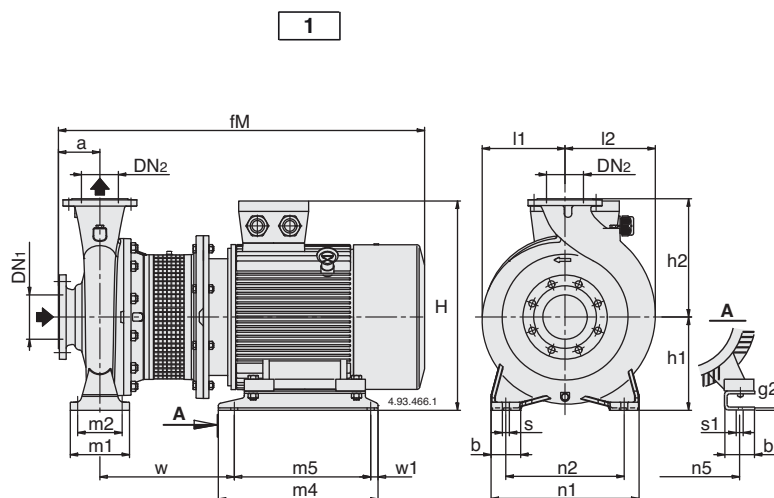

Standard construction - Ejecución normal

Picture Figura	NMS4	mm																				kg			
		DN1	DN2	a	fM	h1	h2	H	m1	m2	n1	n2	n5	w1	b	b1	s	s1	l1	l2	w		m4	m5	g2
1	NMS4 80/315S-60	100	80	125	969	250	315	511	160	120	400	315	279	25	80	78	18	15	220	232	340	432	382	6	
	NMS4 80/400C-60/B	125	80	125	974	280	355	542	160	120	435	355	279	25	80	70	18	15	268	269	318	520	435	6	339
	NMS4 80/400B-60/B	125	80	125	1025	280	355	542	160	120	435	355	279	25	80	70	18	15	268	269	318	520	435	6	355
	NMS4 80/400A-60/B	125	80	125	1025	280	355	580	160	120	435	355	318	25	80	83	18	19	268	269	334	540	455	6	413
	NMS4 80/400S-60	125	80	125	1124	280	355	608	160	120	435	355	356	55	80	103	18	19	268	269	384	540	460	8	490
	NMS4 100/315A-60/A	125	100	140	984	250	315	512	160	120	400	315	279	25	80	70	18	15	230	250	312	432	382	6	308
	NMS4 100/400C-60/A	125	100	140	1040	280	355	542	200	150	500	400	279	25	100	70	22	15	268	280	318	520	435	6	366
	NMS4 100/400B-60/A	125	100	140	1040	280	355	580	200	150	500	400	318	25	100	83	22	19	268	280	334	540	455	6	419
	NMS4 100/400A-60/A	125	100	140	1139	280	355	605	200	150	500	400	356	55	100	103	22	19	268	280	384	540	460	8	506
	NMS4 125/315C-60/A	150	125	140	989	280	355	542	200	150	500	400	279	25	100	70	22	15	247	278	318	520	435	6	331
	NMS4 125/315B-60/A	150	125	140	1040	280	355	542	200	150	500	400	279	25	100	70	22	15	247	278	318	520	435	6	350
	NMS4 125/315A-60/A	150	125	140	1040	280	355	580	200	150	500	400	318	25	100	83	22	19	247	278	334	540	455	6	409
	NMS4 125/400C-60/A	150	125	140	1139	315	400	640	200	150	500	400	356	25	100	103	22	19	280	305	409	540	461	8	524
	NMS4 125/400B-60/A	150	125	140	1199	315	400	640	200	150	500	400	356	25	100	103	22	19	280	305	409	540	461	8	-
	NMS4 125/400A-60/A	150	125	140	1307	315	400	707	200	150	500	400	406	25	100	100	22	24	280	305	454	540	461	8	665
	NMS4 150/315D-60/A	200	150	160	1009	280	400	542	200	150	550	450	279	25	100	70	22	15	260	298	318	520	435	6	349
	NMS4 150/315C-60/A	200	150	160	1060	280	400	542	200	150	550	450	279	25	100	70	22	15	260	298	318	520	435	6	374
	NMS4 150/315B-60/A	200	150	160	1060	280	400	580	200	150	550	450	318	25	100	83	22	19	260	298	334	540	455	6	421
	NMS4 150/315A-60/A	200	150	160	1159	280	400	605	200	150	550	450	356	55	100	103	22	19	260	298	384	540	460	8	501
	NMS4 150/400C-60/A	200	150	160	1219	315	450	640	200	150	550	450	356	25	100	103	22	19	295	328	409	540	461	8	594
NMS4 150/400B-60/A	200	150	160	1277	315	450	707	200	150	550	450	406	25	100	100	22	24	295	328	404	540	461	8	681	
NMS4 150/400A-60/A	200	150	160	1280	315	450	747	200	150	550	450	457	45	100	100	22	24	295	328	432	625	535	6	845	

### Flanges - Bidas EN 1092-2

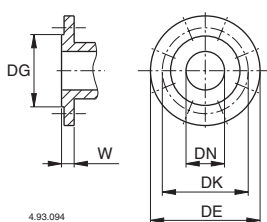

4.93.094

mm						
DN	DG	DK	DE	Holes Agujeros Nº	Ø	W
32	76	100	140	4	19	18
40	84	110	150	4	19	18
50	99	125	165	4	19	20
65	118	145	185	4	19	20
80	132	160	200	8	19	22
100	156	180	220	8	19	24
125	184	210	250	8	19	24
150	211	240	285	8	23	26
200	266	295	340	8	23	30

## Dimensions and weights - Dimensiones y pesos

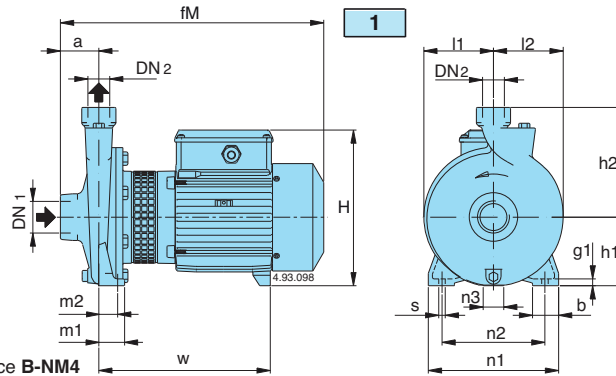

Bronze construction - Ejecución en bronce **B-NM4**

Picture Figura	B-NM4	DN1	DN2	ISO 228	NPT	mm															kg		
						a	fM	h1	h2	H	m1	m2	n1	n2	n3	b	s	l1	l2	w		g	
1	B-NM4 25/160AE-60-BE-60	G 1 1/2	G 1		✓	56	380	100	160	228	37,5	27,5	190	150	30	38	9,5	102	102	250	10	19-19	
	B-NM4 25/200B-60/A-C-60/A					✓	63	400	125	180	253	45	32,5	245	200	49	45	11,5	125	125	250	11	25-23
	B-NM4 25/200A-60/C						440															250	

✓ NPT Version on demand - Ejecuciones bajo demanda

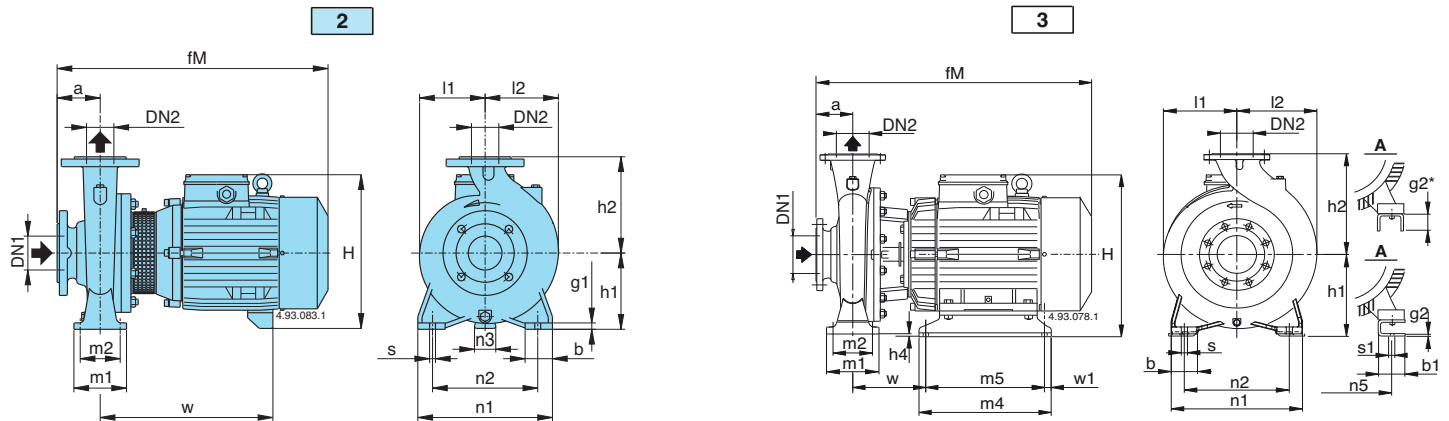

Bronze construction - Ejecución en bronce **B-NM4**

Picture Figura	B-NM4	DN1	DN2	a	fM	h1	h2	H	h4	m1	m2	n1	n2	n3	n5	w1	b	b1	s	s1	l1	l2	w	m4	m5	g1	g2	kg	
2	B-NM4 32/16A-60,B-60	50	32	80	410	132	160	260	-	100	70	240	190	47	-	-	50	-	14	-	120	120	255	-	-	12	-	38-38	
	B-NM4 32/20B-60	50	32	80	410	160	180	288	-	100	70	240	190	62	-	-	50	-	14	-	140	140	255	-	-	12	-	41	
	B-NM4 32/20A-60/A				450																							45	
	B-NM4 40/16B-60,C-60	65	40	80	410	132	160	260	-	100	70	240	190	47	-	-	50	-	14	-	121	121	255	-	-	10	-	36,6-34,7	
B-NM4 40/16A-60/B				450																							43		
B-NM4 40/20A-60/B,B-60/B	65	40	100	495	160	180	298	-	100	70	265	212	62	-	-	50	-	14	-	142	142	295	-	-	12	-	55-55		
3	B-NM4 40/25/C-60/C	65	40	100	535	190	225	318	10	125	95	320	250	-	140	15	65	54	14	10	175	175	156	205	175	-	6	73	
	B-NM4 40/25/A-60/B,B-60/C				560			350							190		60	60	12	12	175	175	125	280	250	-		89-73	
2	B-NM4 50/16A-60/B,B-60/B	65	50	100	495	160	180	298	-	100	70	265	212	62	-	-	50	-	14	-	126	140	295	-	-	12	-	55-55	
3	B-NM4 50/25/C-60/C	65	50	100	560	190	225	350	10	125	95	320	250	-	190	15	65	60	14	12	175	175	125	280	250	-	6	79,5	
	B-NM4 50/25/A-60/B,B-60/B																											105-92	
2	B-NM4 65/16A-60/C,B-60/C,C-60C	80	65	100	495	160	200	306	-	125	95	280	212	62	-	-	65	-	14	-	140	161	300	-	-	12	-	-	60-57-66
	B-NM4 65/16S-60/A				525																		320						
	B-NM4 65/20A-60/A,B-60/A	80	65	100	525	180	225	340	-	125	95	320	250	60	-	-	65	-	14	-	159	179	330	-	-	12	-	-	
	B-NM4 65/25B-60/B	80	65	100	540	200	250	360	-	160	120	360	280	60	-	-	80	-	18	-	179	195	345	-	-	15	-	109	
	B-NM4 65/25A-60/C				645			385															405	-	-	12	-	128	
	B-NM4 65/31C-60/B,B-60/B	80	65	125	670	225	280	410	-	160	120	400	315	75	-	-	80	-	18	-	220	220	415	-	-	20	-	170-..	
	B-NM4 65/31A-60/B				720																		465	-	-	20	-	-	
	B-NM4 80/20A-60,B-60,C-60	100	80	125	560	180	250	340	-	125	95	345	280	60	-	-	65	-	14	-	170	194	340	-	-	15	-	97,2-89,7-..	
	B-NM4 80/25C-60/A	100	80	125	565	200	280	360	-	160	120	400	315	60	-	-	80	-	18	-	191	210	335	-	-	20	-	115	
B-NM4 80/31C-60	100	80	125	720	250	315	435	-	160	120	400	315	90	-	-	80	-	18	-	222	234	465	-	-	17	-	-		
B-NM4 100/20B-60/A,C-60/A	125	100	125	565	200	280	360	-	160	120	360	280	60	-	-	80	-	18	-	180	212	330	-	-	20	-	-	109-103	
B-NM4 100/20A-60/C				665																		385							129

## Dimensions and weights - Dimensiones y pesos

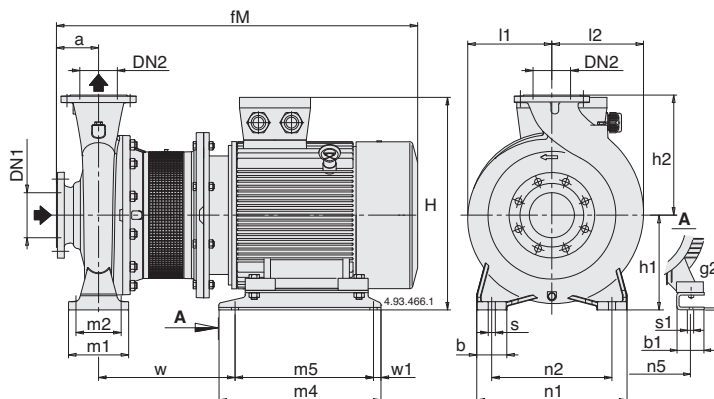

Bronze construction - Ejecución en bronce **B-NMS4**

Picture Figura	B-NMS4	mm																				kg			
		DN1	DN2	a	fM	h1	h2	H	m1	m2	n1	n2	n5	w1	b	b1	s	s1	l1	l2	w		m4	m5	g2
4	BNMS4 80/250A-60/A,B-60/A	100	80	125	807	200	280	387	160	120	400	315	216	20	80	69	18	12	191	210	322	298	258	6	181-171
	BNMS4 80/315B-60/B	100	80	125	948	250	315	457	160	120	400	315	254	20	80	60	18	15	222	234	271	435	395	6	
	BNMS4 80/315A-60/B	100	80	125	948	250	315	457	160	120	400	315	254	20	80	60	18	15	222	234	271	435	395	6	
	BNMS4 80/315S-60	100	80	125	968	250	315	536	160	120	400	315	279	25	80	70	18	15	222	234	312	432	382	6	
	BNMS4 80/400C-60/B	125	80	125	973	280	355	566	160	120	435	355	279	25	80	70	18	15	268	269	318	520	435	6	
	BNMS4 80/400B-60/B	125	80	125	1003	280	355	566	160	120	435	355	279	25	80	70	18	15	268	269	318	520	435	6	
	BNMS4 80/400A-60/B	125	80	125	1051	280	355	595	160	120	435	355	318	25	80	83	18	19	268	269	334	540	455	6	
	BNMS4 80/400S-60	125	80	125	1118	280	355	618	160	120	435	355	356	55	80	103	18	19	268	269	380	540	460	8	
	BNMS4 100/250B-60/A	125	100	140	822	225	280	412	160	120	400	315	216	20	80	69	18	12	205	233	322	298	258	6	192
	BNMS4 100/250A-60/A	125	100	140	872	225	280	412	160	120	400	315	216	20	80	69	18	12	205	233	322	298	258	6	206
	BNMS4 100/315C-60/A	125	100	140	966	250	315	457	160	120	400	315	254	20	80	60	18	15	230	250	274	435	395	6	284
	BNMS4 100/315B-60/A	125	100	140	966	250	315	457	160	120	400	315	254	20	80	60	18	15	230	250	274	435	395	6	300
	BNMS4 100/315A-60/A	125	100	140	983	250	315	536	160	120	400	315	279	25	80	70	18	15	230	250	312	432	382	6	
	BNMS4 100/400C-60/A	125	100	140	1018	280	355	566	200	150	500	400	279	25	100	70	22	15	268	280	318	520	435	6	
	BNMS4 100/400B-60/A	125	100	140	1066	280	355	595	200	150	500	400	318	25	100	83	22	19	268	280	334	540	455	6	
	BNMS4 100/400A-60/A	125	100	140	1138	280	355	618	200	150	500	400	356	55	100	103	22	19	268	280	385	540	460	8	
	BNMS4 125/250D-60/A-E-60/A	150	125	140	822	250	355	437	160	120	400	315	216	20	80	69	18	12	235	268	322	298	258	6	
	BNMS4 125/250C-60/A	150	125	140	872	250	355	437	160	120	400	315	216	20	80	69	18	12	235	268	322	298	258	6	
	BNMS4 125/250B-60/A	150	125	140	951	250	355	457	160	120	400	315	254	20	80	60	18	15	235	268	259	435	395	6	265
	BNMS4 125/250A-60/A	150	125	140	951	250	355	457	160	120	400	315	254	20	80	60	18	15	235	268	259	435	395	6	273
	BNMS4 125/315C-60/A	150	125	140	988	280	355	566	200	150	500	400	279	25	100	70	22	15	247	278	318	520	435	6	383
	BNMS4 125/315B-60/A	150	125	140	1018	280	355	566	200	150	500	400	279	25	100	70	22	15	247	278	318	520	435	6	395
	BNMS4 125/315A-60/A	150	125	140	1066	280	355	595	200	150	500	400	318	25	100	83	22	19	247	278	334	540	455	6	
	BNMS4 125/400C-60/A	150	125	140	1138	315	400	653	200	150	500	400	356	25	100	103	22	19	280	305	410	540	461	8	
	BNMS4 125/400B-60/A	150	125	140	1198	315	400	653	200	150	500	400	356	25	100	103	22	19	280	305	410	540	461	8	
	BNMS4 125/400A-60/A	150	125	140	1237	315	400	725	200	150	500	400	406	25	100	100	22	24	280	305	454	540	461	8	
	BNMS4 150/315D-60	200	150	160	1008	280	400	566	200	150	550	450	279	25	100	70	22	15	260	298	318	520	435	6	380
	BNMS4 150/315C-60/A	200	150	160	1038	280	400	566	200	150	550	450	279	25	100	70	22	15	260	298	318	520	435	6	395
	BNMS4 150/315B-60/A	200	150	160	1086	280	400	595	200	150	550	450	318	25	100	83	22	19	260	298	334	540	455	6	467
	BNMS4 150/315A-60/A	200	150	160	1158	280	400	618	200	150	550	450	356	55	100	103	22	19	260	298	385	540	460	8	544
BNMS4 150/400C-60/A	200	150	160	1218	315	450	653	200	150	550	450	356	25	100	103	22	19	295	328	410	540	461	8		
BNMS4 150/400B-60/A	200	150	160	1257	315	450	725	200	150	550	450	406	25	100	100	22	24	295	328	454	540	461	8		
BNMS4 150/400A-60/A	200	150	160	1330	315	450	748	200	150	550	450	457	45	100	100	22	24	295	328	482	625	535	6		

Flanges - Bidas EN 1092-2

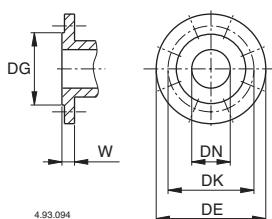

mm						
DN	DG	DK	DE	Holes		
				N°	Ø	W
32	76	100	140	4	19	18
40	84	110	150	4	19	18
50	99	125	165	4	19	20
65	118	145	185	4	19	20
80	132	160	200	8	19	22
100	156	180	220	8	19	24
125	184	210	250	8	19	24
150	211	240	285	8	23	26
200	266	295	340	8	23	30



## Features - Características constructivas

### NM4

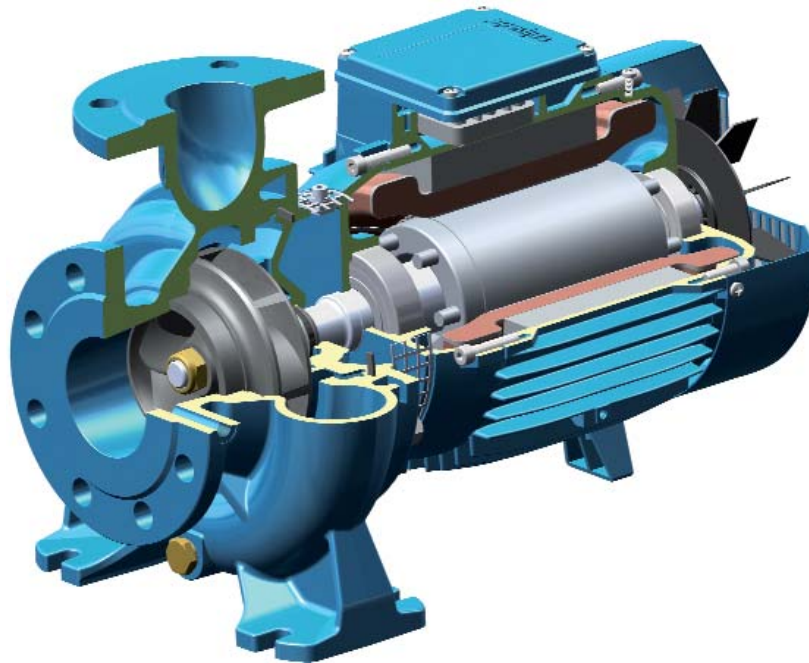

#### Cutting edge hydraulics

The geometry of the impeller and the pump casing are optimized to achieve maximum efficiency and the best suction capability.

#### Flexibility

The option to choose between cast iron and bronze materials for the hydraulic parts in contact with the pumped liquid allows NM4 series pumps to be selected for use with different types of liquids.

#### Compact Design

The compact design allows for easy installation even in confined spaces.

#### Exclusive design

An innovative, patented guard prevents contact with rotating parts, proving protection to the end user whilst allowing for inspection of the mechanical seal.

#### Reliability

The bearing and shaft are designed to ensure the reduction of the stress, providing high reliability under all operating conditions.

#### Hidráulica de vanguardia

La geometría del impulsor y la carcasa de la bomba han sido mejoradas para conseguir la máxima eficiencia y la mejor capacidad de succión.

#### Flexibilidad

La opción de poder elegir entre hierro fundido y bronce para las partes hidráulicas en contacto con el bombeo permite que las bombas de la serie NM4 puedan ser seleccionadas para utilizar con diferentes tipos de líquidos.

#### Diseño compacto

El diseño compacto permite una fácil instalación incluso en espacios confinados.

#### Diseño exclusivo

Un innovador protector patentado evita el contacto con las partes rotantes, lo que demuestra la protección para el usuario final mientras le permite la inspección del sello mecánico.

#### Fiabilidad

El cojinete y el eje están diseñados para asegurar la reducción de la tensión, proporcionando alta fiabilidad en todas las condiciones.

## Features - Características constructivas

### NMS4

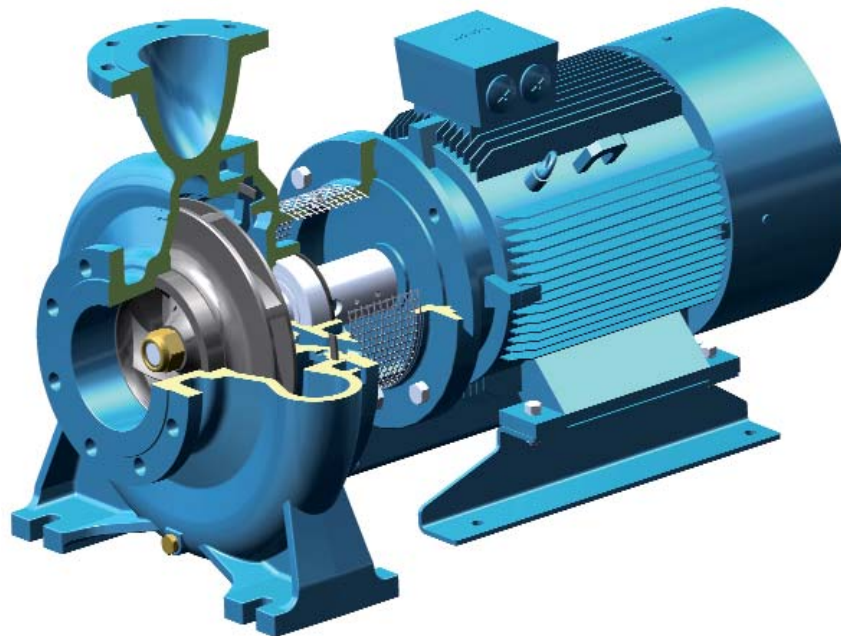

#### Cutting edge hydraulics

The geometry of the impeller and the pump casing are optimized to achieve maximum efficiency and the best suction capability.

#### Flexibility

The option to choose between cast iron and bronze materials for the hydraulic parts in contact with the pumped liquid allows NMS4 series pumps to be selected for use with different types of liquids.

#### New lantern bracket construction

The lantern brackets incorporate a thrust bearing on the hydraulic side which guarantees the elimination of additional loads on the motor bearings. The flange is sized to be used with standard motors B35.

#### Exclusive design

An innovative, patented guard prevents contact with rotating parts, proving protection to the end user whilst allowing for inspection of the mechanical seal.

#### Simplified motor maintenance

The presence of the thrust bearing on the hydraulic side makes it easier to remove the motor, facilitating maintenance operations and eliminating the risks of damage to the hydraulic parts.

#### Hidráulica de vanguardia

La geometría del impulsor y la carcasa de la bomba han sido mejoradas para conseguir la máxima eficiencia y la mejor capacidad de succión.

#### Flexibilidad

La opción de poder elegir entre hierro fundido y bronce para las partes hidráulicas en contacto con el bombeo permite que las bombas de la serie NMS4 puedan ser seleccionadas para utilizar con diferentes tipos de líquidos.

#### Nuevo acoplamiento

El acoplamiento incorpora un rodamiento de empuje del lateral hidráulico que garantiza la eliminación de cargas en los cojinetes del motor. La brida está dimensionada para utilizarse con motores B35 estándar.

#### Diseño exclusivo

Un innovador protector patentado evita el contacto con las partes rotantes, lo que demuestra la protección para el usuario final mientras le permite la inspección del sello mecánico.

#### Mantenimiento del motor simplificado

La presencia del cojinete de empuje en la parte hidráulica hace que sea más fácil quitar el motor, lo que facilita el mantenimiento de operaciones eliminando los riesgos de daños a las piezas hidráulicas.